

Hisense

EXTERNAL RS232 CONTROL GUIDE

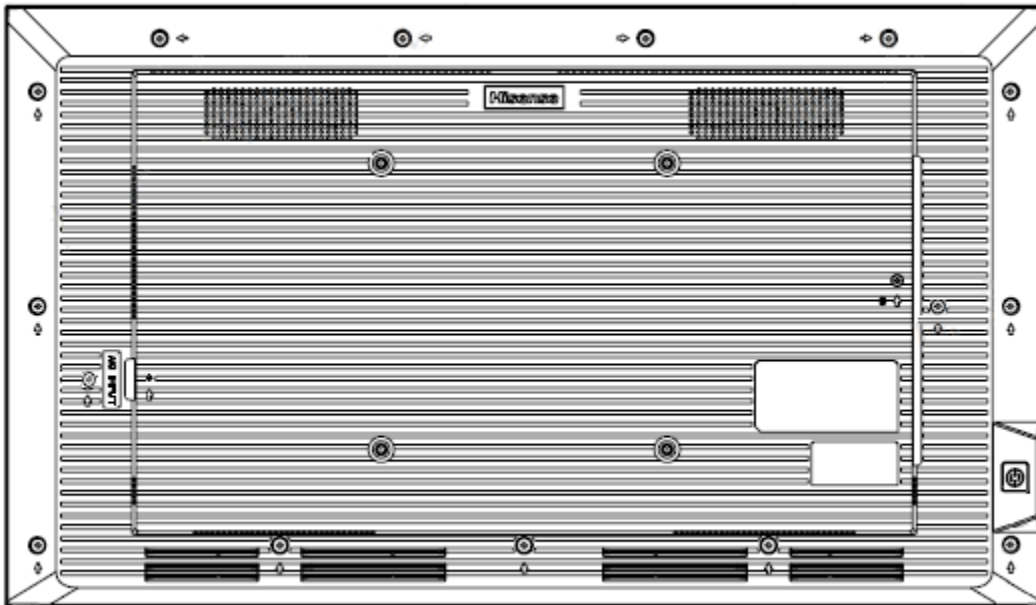

32/43/50/55/65/75/86DM66D

43/50/55/65/75/86GM50D

46/55VW25E

55WH80E/55WH80F

Note: The terminals of different models may be different, please refer to the actual ones.

Version & Revision History

Version	Description	Date
V1.0	The initial release	2023-12
V1.1	<ol style="list-style-type: none"> 1. Fix the example command of “Set Screen Aspect Ratio” 2. Fix the example command of “Query Screen Status” 3. Add note of “Monitor ID” 4. Fix “Power On” Command. The range of Monitor ID can be set from 0x00 -0xFF. 	2024-8-15
V1.2	<ol style="list-style-type: none"> 1. Add command of “HDMI3 Input” 	2025-3-31
V1.3	<ol style="list-style-type: none"> 1. Add command “Set Max_Backlight” 2. Add command “Set Min_Backlight” 3. Add command “Set Brightness_Ambient Light” 4. Add command “Set All Ambient Light” 5. Add command “Query Max_Backlight” 6. Add command “Query Min_Backlight” 7. Add command “Query Brightness_Ambient Light” 8. Add command “Query All Ambient Light” 	2025-5-16

INTRODUCTION

Our users can control a Hisense display from an external source via RS-232. This user guide will provide all of the command structures and system parameters required to confidently control Hisense commercial displays via a PC or a 3rd party control system.

FORMATS

HISENSE RS232 commands are HEX codes, not ASCII format.

Where applicable, codes contain the ID of the screen you are trying to control. A value of "00" will broadcast the command to all of the screens connected to the RS232 port, for this case, there is no feedback from devices. This might be all of the panels in a video wall daisy chained together for control. A value of "01" for example, will lead to control of the panel with ID 01 only. The default ID of the device is 01, each device in a video wall must set a unique ID. If the ID in command is different with the device ID, there is no feedback from device and this command cannot work. Depending on device configuration, some commands may not work, please check details below.

If you encounter problems when using RS-232 command, for example, the command cannot find or work, please try to upgrade device software to latest version.

RS232 commands require an XOR operation on some of its HEX bytes in order to generate the "checksum byte". Example codes are given and XOR calculations can be made using this online calculator: <https://onlinehextools.com/xor-hex-numbers>

Each HEX number from the code that needs to be XORed is input into the left hand box on the page, each on a separate line. The XORed result is shown in the right hand box on the page.

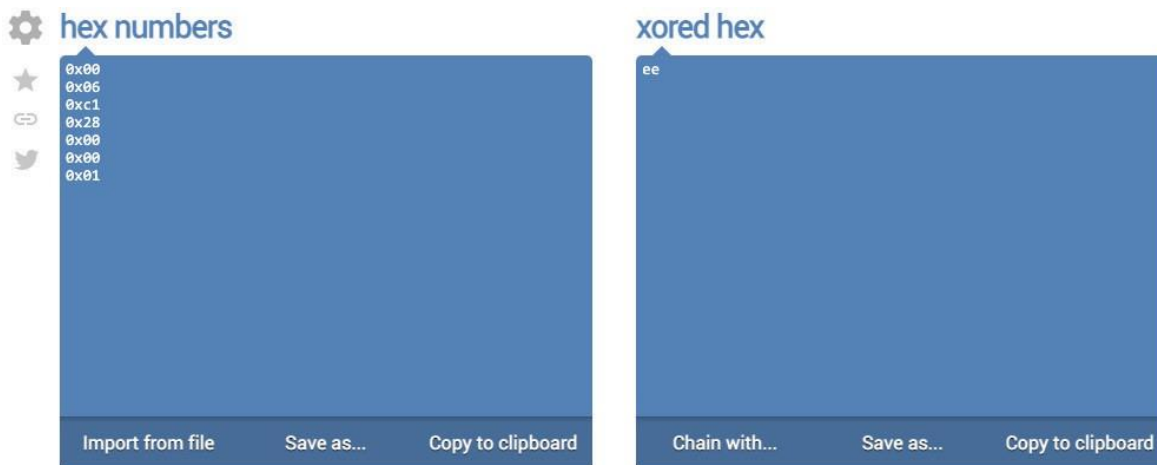

You may install USB-to-Serial Bridge Driver, and RS232 serial terminal software on your PC, for example, Hercules SETUP utility or SSCOM.

DM66D SERIES - 24/7 DIGITAL SIGNAGE

GM50D SERIES - 18/7 DIGITAL SIGNAGE

Connectivity Diagram

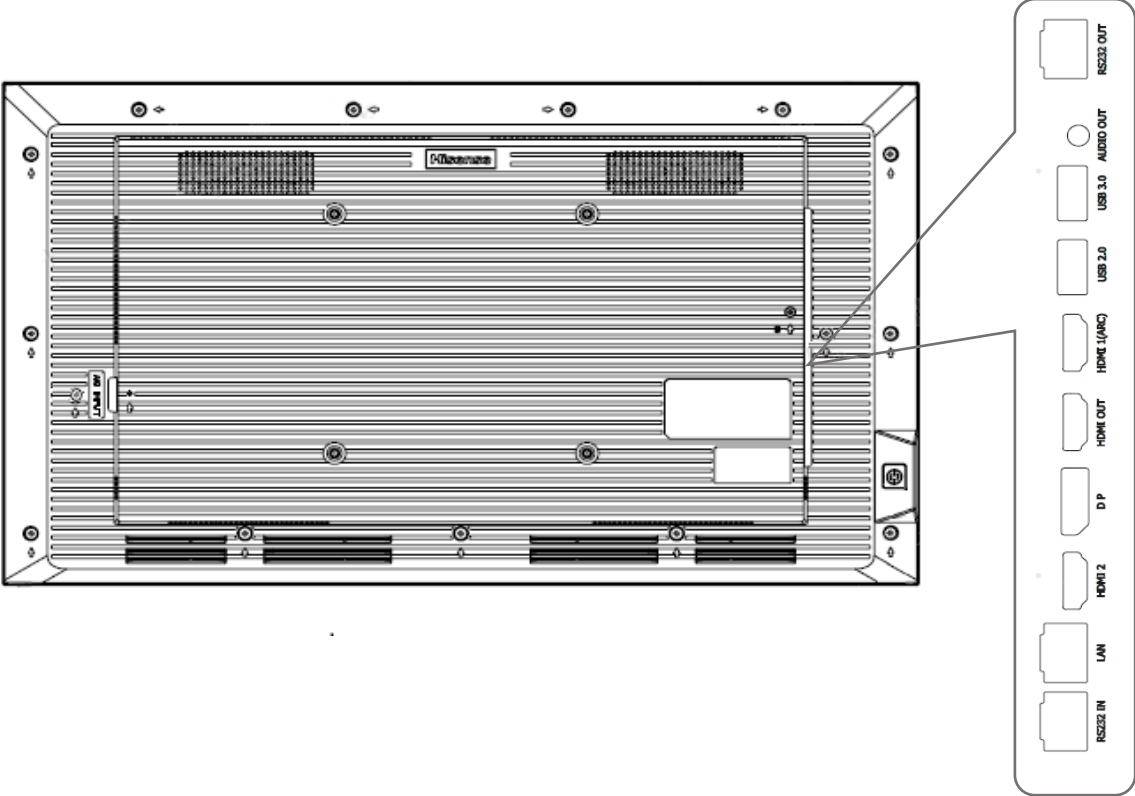

VW25E SERIES - 24/7 VIDEO WALL

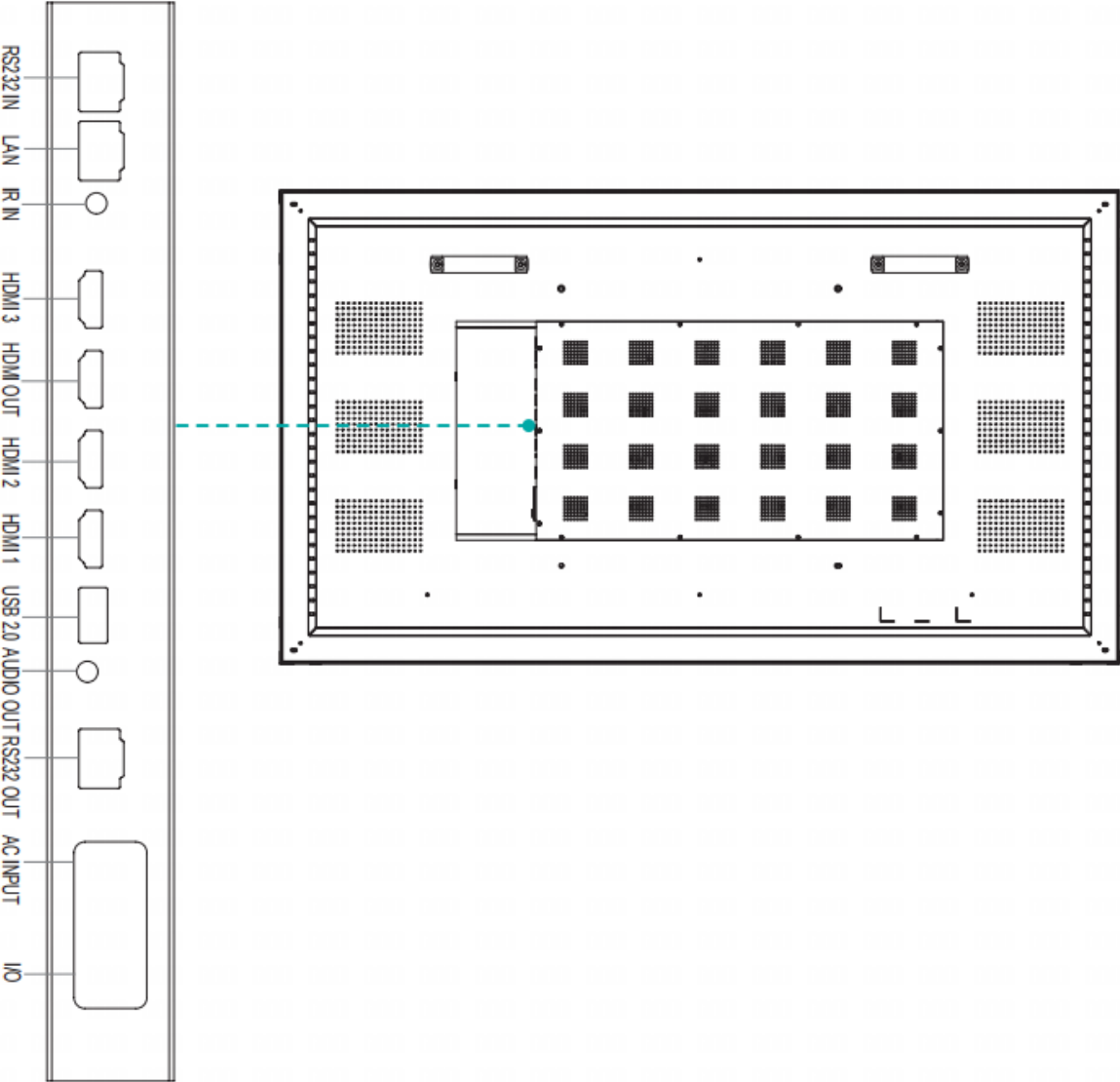

55WH80E/55WH80F SERIES - 24/7 WINDOW FACING

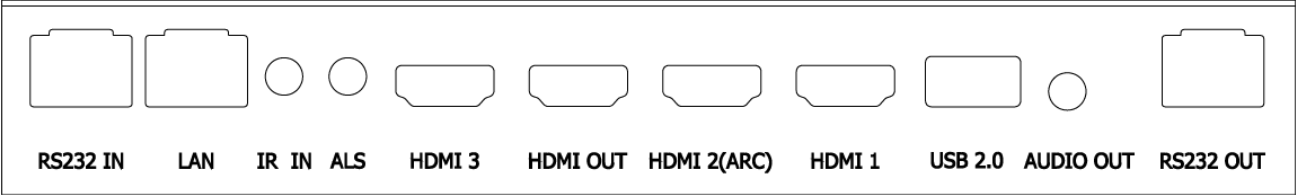
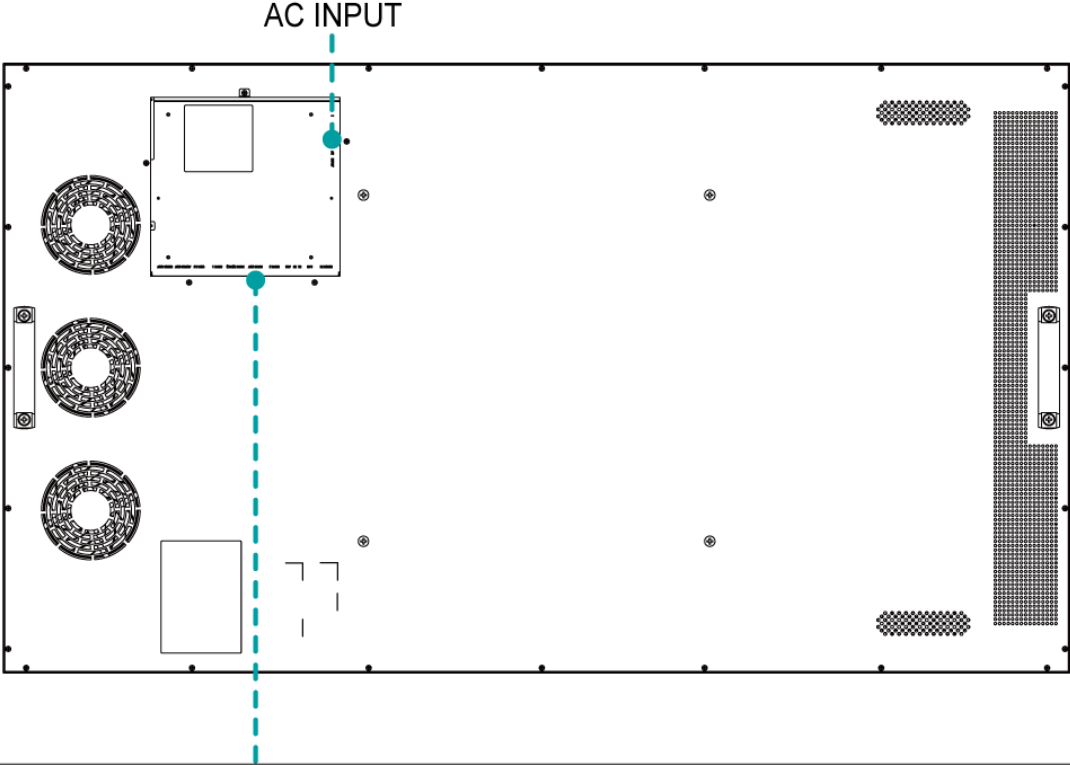

RS232 Connectivity Illustration

The following graphs illustrate the connectivity between a PC and the device.

There is already a RJ45-RS232 cable in box, if you'd like to use USB port on PC, you may want to prepare a USB-RS232 cable in advance, please note that the DB-9 connectors of the two cables should be male/female in pairs for this case.

Dispaly Pin Configuration

RS232 -IN RJ-45 Jack (Female)

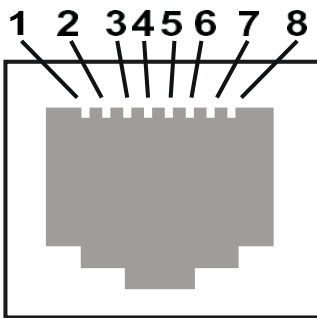

Pin	Signal
1	
2	
3	GND
4	IR
5	RX(for Display)
6	+5VDC
7	
8	TX(for Display)

Note: If IR input is not required, leave pin4&pin6 NC. Do not connect any other wire.

The wiring method is as follows.

Method 1 : Connect the computer directly to the display

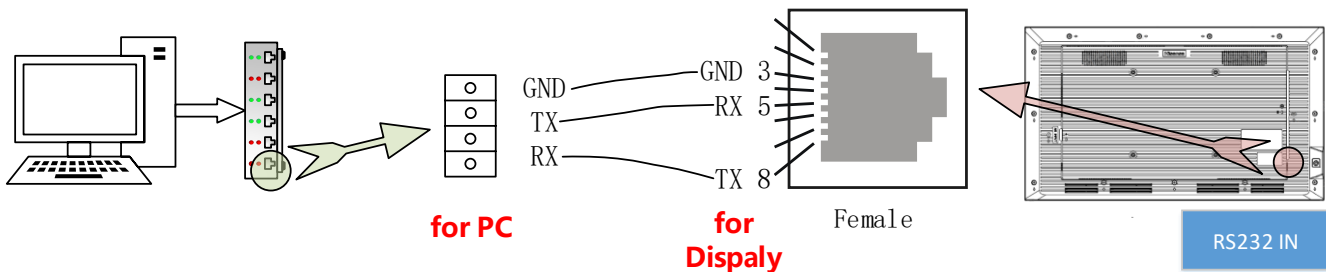

Method 2 :Using attachment lines



Included in the box – 1 x RJ45(Male) – DB-9F(Female)-RS 232 cable

Please use table below when wiring a cable:

Pin out Connection	
RJ45(Male)	DB-9F(Female)

1	
2	
3	5
4	
5	3
6	
7	
8	2

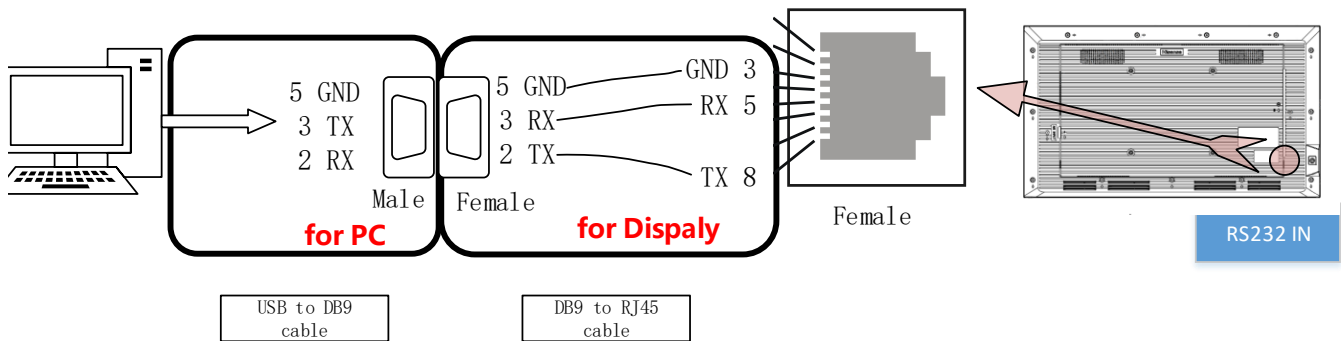

Data Parameters

DM/GM-SERIES	
Baud Rate	9600
Data length (bits)	8
Parity	None
Stop bit	1
Flow control	None

Command Format

PC -> TV:

Header (2 Bytes)		Length (2 Bytes)		Command (4 Bytes)				Monitor ID (1 Byte)	Data (N Bytes)			Checksum (1 Bytes)	End (2 Bytes)	
DD	FF												BB	CC

TV -> PC:

Header (2 Bytes)		Length (2 Bytes)		Command (4 Bytes)				Monitor ID (1 Byte)	Data (N Bytes)			Checksum (1 Bytes)	End (2 Bytes)	
AB	AB												CD	CD

Note:

1. Length is the number of bytes of Command, Data and Checksum
2. Checksum is XOR of Length, Command, Monitor ID and Data

3. Monitor ID. The range of Monitor ID is from 0x01 to 0xFF, supporting 255 devices to be connected to the network. 0x00 is the broadcast address, and all devices will execute the instructions sent with this ID, but will not return the instructions.

RS232 Command

Description	Command (HEX Bytes)	Example (PC -> TV ID 01)	TV -> PC
Power On	DD FF 00 08 C1 15 00 00 xx BB BB yy BB CC	Ddff0008C115000001BBBBDBBCC	AB AB 00 08 C1 15 00 00 xx BB BB yy CD CD When TV is in standby state, send this command will get one feedback from TV, once TV starts up, it will send feedback again.
Power Off	DD FF 00 08 C1 15 00 00 xx AA AA yy BB CC	DD FF 00 08 C1 15 00 00 01 AA AA DD BB CC	AB AB 00 08 C1 15 00 00 xx AA AA yy CD CD
Screen Off	DD FF 00 07 C1 31 00 00 xx 00 yy BB CC	DD FF 00 07 C1 31 00 00 01 00 F6 BB CC	AB AB 00 07 C1 31 00 00 xx 00 yy CD CD
Screen On	DD FF 00 07 C1 31 00 00 xx 01 yy BB CC	DD FF 00 07 C1 31 00 00 01 01 F7 BB CC	AB AB 00 07 C1 31 00 00 xx 01 yy CD CD
Reboot	DD FF 00 06 C1 1E 00 00 xx yy BB CC	DD FF 00 06 C1 1E 00 00 01 D8 BB CC	AB AB 00 06 C1 1E 00 00 xx yy CD CD
Set AC Power On Mode	DD FF 00 07 C1 FF 00 09 xx zz yy BB CC	Ddff0007C1FF0009010031BBCC zz: power on mode. 00 – direct, 01 – last, 02 – standby direct: DD FF 00 07 C1 FF 00 09 01 00 31 BB CC last: DD FF 00 07 C1 FF 00 09 01 01 30 BB CC standby: DD FF 00 07 C1 FF 00 09 01 02 33 BB CC	AB AB 00 07 C1 FF 00 09 xx zz yy CD CD
DP Input	DD FF 00 07 C1 08 00 00 xx 16 yy BB CC	Ddff0007C10800000116D9BBCC	AB AB 00 07 C1 08 00 00 xx 16 yy CD CD
VGA Input	DD FF 00 07 C1 08 00 00 xx 17 yy BB CC	Ddff0007C10800000117D8BBCC	AB AB 00 07 C1 08 00 00 xx 17 yy CD CD
HDMI1 Input	DD FF 00 07 C1 08 00 00 xx 0E yy BB CC	Ddff0007C1080000010EC1BBCC	AB AB 00 07 C1 08 00 00 xx 0E yy CD CD
HDMI2 Input	DD FF 00 07 C1 08 00 00 xx 0F yy BB CC	Ddff0007C1080000010FC0BBCC	AB AB 00 07 C1 08 00 00 xx 0F yy CD CD
HDMI3 Input	DD FF 00 07 C1 08 00 00 xx 10 yy BB CC	Ddff0007C1080000010DFBCC	AB AB 00 07 C1 08 00 00 xx 10 yy CD CD
PC Input	DD FF 00 07 C1 08 00 00 xx 0C yy BB CC	Ddff0007C1080000010CC3BBCC	AB AB 00 07 C1 08 00 00 xx 0C yy CD CD
DVI Input	DD FF 00 07 C1 08 00 00 xx 09 yy BB CC	Ddff0007C10800000109C6BBCC	AB AB 00 07 C1 08 00 00 xx 09 yy CD CD
Set Screen Aspect Ratio	DD FF 00 07 C1 35 00 00 xx zz yy BB CC Once this command is set, reboot TV, it will show with expected ratio	Landscape: DD FF 00 07 C1 35 00 00 00 00 F3 BB CC Portrait: DD FF 00 07 C1 35 00 00 00 01 F2 BB CC	AB AB 00 07 C1 35 00 00 xx zz yy CD CD
Set Mute	DD FF 00 07 C1 26 00 00 xx 01 yy BB CC	Ddff0007C12600000101E0BBCC	AB AB 00 07 C1 26 00 00 xx 01 yy CD CD
Set Unmute	DD FF 00 07 C1 26 00 00 xx 00 yy BB CC	Ddff0007C12600000100E1BBCC	AB AB 00 07 C1 26 00 00 xx 00 yy CD CD

Set Volume	DD FF 00 07 C1 27 00 00 xx zz yy BB CC	DFFF0007C12700000101E1BBCC zz: volume range 0-100	AB AB 00 07 C1 27 00 00 xx zz yy CD CD
Set Backlight Brightness	DD FF 00 08 C1 32 00 00 xx 06 zz yy BB CC	ex: set brightness to 32 - zz = 0x20 DFFF0008C1320000010620DCBBCC	AB AB 00 08 C1 32 00 00 xx 06 zz CD CD
Set Backlight Brightness Auto Adjust	DD FF 00 07 C1 34 00 00 xx zz yy BB CC	ex: set brightness auto adjust off DFFF0007C13400000100F3BBCC zz = 00 - off, 01 - on	AB AB 00 07 C1 34 00 00 xx zz yy CD CD
Set Date	DD FF 00 09 C1 1C 00 00 xx zz zz zz yy BB CC	ex: set date to 23.Jan.2 DFFF0009C11C000001170102C1BB CC zz zz zz = Year Month Day	AB AB 00 09 C1 1C 00 00 xx zz zz zz yy CD CD zz zz zz = FF FF FF when error
Set Time	DD FF 00 09 C1 1D 00 00 xx zz zz zz yy BB CC	ex: set time to 12:25:2 DFFF0009C11D0000010C1902C3BB CC zz zz zz = Hour Minute Second	AB AB 00 09 C1 1D 00 00 xx zz zz zz yy CD CD zz zz zz = FF FF FF when error
Set Schedule for Power On	DD FF 00 09 C1 3E 00 00 xx tt zz zz yy BB CC	ex: power on at 9:10 every day DFFF0009C13E00000101090AF5BB CC tt = 00 - turn off schedule, 01 - everyday zz zz = Hour Minute Tips: If the device has been set to power on and off at a scheduled time, sending this command will clear the original settings, and leaving only the one sent.	AB AB 00 09 C1 3E 00 00 xx zz zz zz yy CD CD
Set Schedule for Power Off	DD FF 00 09 C1 3F 00 00 xx tt zz zz yy BB CC	ex: power off at 18:10 every day DFFF0009C13F00000101120AEFBB CC tt = 0 - turn off schedule, 1 - everyday zz zz = Hour Minute Tips: If the device has been set with a timed power on/off command, all previously set power on/off will be turned off	AB AB 00 09 C1 3F 00 00 xx zz zz zz yy CD CD
Set Brightness	DD FF 00 07 C1 36 00 00 xx zz yy BB CC current source must be: DP, VGA, HDMI, PC, DVI	ex: set brightness to 32 - zz = 0x20 DFFF0007C13600000120D1BBCC	AB AB 00 07 C1 36 00 00 xx zz yy CD CD
Set Contrast	DD FF 00 07 C1 37 00 00 xx zz yy BB CC current source must be: DP, VGA, HDMI, PC, DVI	ex: set contrast to 32 - zz = 0x20 DFFF0007C13700000120D0BBCC	AB AB 00 07 C1 37 00 00 xx zz yy CD CD
Set Sharpness	DD FF 00 07 C1 38 00 00 xx zz yy BB CC current source must be: DP, VGA, HDMI, PC, DVI	ex: set sharpness to 32 - zz = 0x20 DFFF0007C13800000120DFBBCC	AB AB 00 07 C1 38 00 00 xx zz yy CD CD
Set Color Temperature	DD FF 00 07 C1 39 00 00 xx zz yy BB CC current source must be: DP, VGA, HDMI, PC, DVI	ex: set colour temperature to 32 - zz = 0x20 DFFF0007C13900000120DEBBCC	AB AB 00 07 C1 39 00 00 xx zz yy CD CD

Set Noise Reduction	DD FF 00 07 C1 3A 00 00 xx zz yy BB CC current source must be: DP, VGA, HDMI, PC, DVI	ex: set noise reduction to High - zz = 0x03 DDFF0007C13A00000103FEBBCC zz = 01 - low, 02 - medium, 03 - high, 04 - auto, 00 – off	AB AB 00 07 C1 3A 00 00 xx zz yy CD CD												
Set Image Scaling	DD FF 00 07 C1 3B 00 00 xx zz yy BB CC current source must be: DP, VGA, HDMI, PC, DVI	ex: set image scaling to Full - zz = 0x03 DDFF0007C13B00000103FFBBCC zz = 00 - full, 01 - 16:9, 02 - 4:3, 03 - scaling 1, 04 - scaling 2, 05 - point to point	AB AB 00 07 C1 3B 00 00 xx zz yy CD CD												
Set Picture Mode	DD FF 00 07 C1 0F 06 00 xx zz yy BB CC	ex: set picture mode to movie mode - zz = 0x03 DDFF0007C10F060001030CBBCC zz = 00 - standard, 01 - bright, 02 - soft, 03 - Movie, 04 - Text, 5 - gaming 12 – natural	AB AB 00 07 C1 0F 06 00 xx zz yy CD CD												
Set Sound Mode	DD FF 00 07 C1 FF 00 03 xx zz yy BB CC	ex: set sound mode to standard mode - zz = 0x00 DDFF0007C1FF000301003BBBCC zz = 00 - standard, 01 - music, 02 - news, 08 - movie, 10 - sports, 20 - custom, 30 - voice, 40 - meeting	AB AB 00 07 C1 FF 00 03 xx zz yy CD CD												
Set Eye Protection Mode	DD FF 00 07 C1 FF 00 1E xx zz yy BB CC	ex: set eye protection mode on - zz = 0x01 DDFF0007C1FF001E010127BBCC zz = 00 - off, 01 - on	AB AB 00 07 C1 FF 00 1E xx zz yy CD CD												
VGA Auto Adjust	DD FF 00 07 C1 01 00 00 xx yy BB CC current source must be VGA	ex: VGA Auto Adjust DDFF0007C101000001C6BBCC zz = 00 - off, 01 – on	AB AB 00 07 C1 01 00 00 xx yy CD CD												
Set anti-burn-in (image retention)	DD FF 00 07 C1 33 00 00 xx zz yy BB CC	ex: set anti-burn-in on DDFF0007C13300000101F4BBCC zz = 00 - off, 01 - on	AB AB 00 07 C1 33 00 00 xx zz yy CD CD												
Set Power on delay	DD FF 00 07 C1 3C 00 00 xx zz yy BB CC	ex: set power on delay to 10s DDFF0007C13C0000010AF1BBCC zz = 00 - off, others - delay time, range: 2s - 255s	AB AB 00 07 C1 3C 00 00 xx zz yy CD CD												
Set Video Wall	DD FF 00 09 C1 0A 00 00 xx zz zz zz yy BB CC	ex: vertical 3 devices, horizontal 4 devices, device position: 6 DDFF0009C10A000001030406C2BB CC zz: how many devices in vertical zz: how many devices in horizontal zz: current device position	AB AB 00 09 C1 0A 00 00 xx zz zz zz yy CD CD <table border="1" data-bbox="1128 1407 1437 1522"> <tr><td>1</td><td>2</td><td>3</td></tr> <tr><td>4</td><td>5</td><td>6</td></tr> <tr><td>7</td><td>8</td><td>9</td></tr> <tr><td>10</td><td>11</td><td>12</td></tr> </table>	1	2	3	4	5	6	7	8	9	10	11	12
1	2	3													
4	5	6													
7	8	9													
10	11	12													
Set Static IP Address of LAN	DD FF 00 16 C1 1B 30 00 xx zz ... zz yy BB CC	Ex: set IP 10.16.150.225, subnet mask: 255.255.248.0, gateway: 10.16.144.1, DNS: 10.16.144.2 DDFF0016C11B3000010A1096E1FFF FF8000A1090010A10900249BBCC zz .. zz - 16 bytes, IP address - 4 bytes, Subnet mask - 4 bytes, gateway - 4 bytes, DNS - 4 bytes	AB AB 00 16 C1 1B 30 00 xx zz ... zz yy CD CD												

Set USB Lock	DD FF 00 07 C1 FF 00 0E xx zz yy BB CC	ex: lock USB DDFF0007C1FF000E010036BBCC zz = 00 - lock USB, 01 - enable USB	AB AB 00 07 C1 FF 00 0E xx zz yy CD CD																								
Factory Reset	DD FF 00 06 C1 10 00 00 xx yy BB CC	DDFF0006C110000001D6BBCC	AB AB 00 06 C1 10 00 00 xx yy CD CD																								
Set Max_Backlight	DD FF 00 07 C1 0F 00 05 xx zz yy BB CC	DD FF 00 07 C1 0F 00 05 01 50 9D BB CC zz: the max backlight, range: 50-100 (0x32- 0x64)	AB AB 00 07 C1 0F 00 05 xx zz yy CD CD																								
Set Min_Backlight	DD FF 00 07 C1 0F 00 06 xx zz yy BB CC	DD FF 00 07 C1 0F 00 06 01 14 DA BB CC zz: the min backlight, range: 0-49 (0x00- 0x31)	AB AB 00 07 C1 0F 00 06 xx zz yy CD CD																								
Set Brightness_Ambient Light	DD FF 00 09 C1 0F 00 07 xx zz1 zz2 zz3 yy BB CC	DD FF 00 09 C1 0F 00 07 01 02 03 20 E0 BB CC The device with ID 01 and brightness 20 corresponds to an ambient light setting of 800 lux. Note: zz1: represents the corresponding brightness level. The corresponding relationship is as follows: <table border="1" data-bbox="701 852 1094 1224"> <thead> <tr> <th>zz1</th> <th>Brightness_</th> </tr> </thead> <tbody> <tr><td>0x00</td><td>0</td></tr> <tr><td>0x01</td><td>10</td></tr> <tr><td>0x02</td><td>20</td></tr> <tr><td>0x03</td><td>30</td></tr> <tr><td>0x04</td><td>40</td></tr> <tr><td>0x05</td><td>50</td></tr> <tr><td>0x06</td><td>60</td></tr> <tr><td>0x07</td><td>70</td></tr> <tr><td>0x08</td><td>80</td></tr> <tr><td>0x09</td><td>90</td></tr> <tr><td>0x0A</td><td>100</td></tr> </tbody> </table> zz2 zz3: Ambient light corresponding to each stage of brightness. Please set it within the corresponding range. 2000lux -> zz2 zz3: 0x 07 0xD0	zz1	Brightness_	0x00	0	0x01	10	0x02	20	0x03	30	0x04	40	0x05	50	0x06	60	0x07	70	0x08	80	0x09	90	0x0A	100	AB AB 00 09 C1 0F 00 07 xx zz1 zz2 zz3 yy CD CD
zz1	Brightness_																										
0x00	0																										
0x01	10																										
0x02	20																										
0x03	30																										
0x04	40																										
0x05	50																										
0x06	60																										
0x07	70																										
0x08	80																										
0x09	90																										
0x0A	100																										
Set All Ambient Light	DD FF 00 1C C1 0F 00 08 xx zz1 zz2 ... zz22 yy BB CC	<table border="1" data-bbox="701 1371 1094 1875"> <thead> <tr> <th>Data</th> <th>Brightn ess_</th> <th>Ambient Light</th> </tr> </thead> <tbody> <tr> <td>zz1 zz2</td> <td>0</td> <td>0-487 (0x00 0x00 - 0x01 0xE7)</td> </tr> <tr> <td>Zz3 zz4</td> <td>10</td> <td>500-987 (0x01 0xF4- 0x03 0xDB)</td> </tr> <tr> <td>Zz5 zz6</td> <td>20</td> <td>1000-1487 (0x03 0xE8 - 0x05 0xCF)</td> </tr> <tr> <td>Zz7 zz8</td> <td>30</td> <td>1500-1987 (0x05 0xDC - 0x07 0xC3)</td> </tr> <tr> <td>Zz9 zz10</td> <td>40</td> <td>2000-3987 (0x07 0xD0 - 0x0F 0x93)</td> </tr> </tbody> </table>	Data	Brightn ess_	Ambient Light	zz1 zz2	0	0-487 (0x00 0x00 - 0x01 0xE7)	Zz3 zz4	10	500-987 (0x01 0xF4- 0x03 0xDB)	Zz5 zz6	20	1000-1487 (0x03 0xE8 - 0x05 0xCF)	Zz7 zz8	30	1500-1987 (0x05 0xDC - 0x07 0xC3)	Zz9 zz10	40	2000-3987 (0x07 0xD0 - 0x0F 0x93)	AB AB 00 1C C1 0F 00 08 xx zz1 zz2 ... zz22 yy CD CD						
Data	Brightn ess_	Ambient Light																									
zz1 zz2	0	0-487 (0x00 0x00 - 0x01 0xE7)																									
Zz3 zz4	10	500-987 (0x01 0xF4- 0x03 0xDB)																									
Zz5 zz6	20	1000-1487 (0x03 0xE8 - 0x05 0xCF)																									
Zz7 zz8	30	1500-1987 (0x05 0xDC - 0x07 0xC3)																									
Zz9 zz10	40	2000-3987 (0x07 0xD0 - 0x0F 0x93)																									

		<table border="1"> <tr> <td>zz11 zz12</td> <td>50</td> <td>4000-9987 (0x01 0x90 – 0x27 0x03)</td> </tr> <tr> <td>zz13 zz14</td> <td>60</td> <td>10000-16987 (0x27 0x10 – 0x42 0x5B)</td> </tr> <tr> <td>zz15 zz16</td> <td>70</td> <td>17000-21987 (0x42 0x68 – 0x55 0xE3)</td> </tr> <tr> <td>zz17 zz18</td> <td>80</td> <td>22000-25987 (0x55 0xF0 – 0x65 0x83)</td> </tr> <tr> <td>zz19 zz20</td> <td>90</td> <td>26000-29987 (0x65 0x90 – 0x75 0x23)</td> </tr> <tr> <td>Zz21 zz22</td> <td>100</td> <td>30000-88000 (0x75 0x30 – 0x01 0x57 0xC0)</td> </tr> </table>	zz11 zz12	50	4000-9987 (0x01 0x90 – 0x27 0x03)	zz13 zz14	60	10000-16987 (0x27 0x10 – 0x42 0x5B)	zz15 zz16	70	17000-21987 (0x42 0x68 – 0x55 0xE3)	zz17 zz18	80	22000-25987 (0x55 0xF0 – 0x65 0x83)	zz19 zz20	90	26000-29987 (0x65 0x90 – 0x75 0x23)	Zz21 zz22	100	30000-88000 (0x75 0x30 – 0x01 0x57 0xC0)	
zz11 zz12	50	4000-9987 (0x01 0x90 – 0x27 0x03)																			
zz13 zz14	60	10000-16987 (0x27 0x10 – 0x42 0x5B)																			
zz15 zz16	70	17000-21987 (0x42 0x68 – 0x55 0xE3)																			
zz17 zz18	80	22000-25987 (0x55 0xF0 – 0x65 0x83)																			
zz19 zz20	90	26000-29987 (0x65 0x90 – 0x75 0x23)																			
Zz21 zz22	100	30000-88000 (0x75 0x30 – 0x01 0x57 0xC0)																			
Query TV Status	DD FF 00 06 C1 28 00 00 xx yy BB CC	DDFF0006C128000001EEBBCC	AB AB 00 0C C1 28 00 00 xx zz zz zz zz zz yy CD CD zz: volume zz zz: 05 01 - PC, 05 02 - DVI, 05 03 - DP, 05 04 - HDMI2, 05 05 - HDMI1, 08 01 - VGA zz: 00 - power on, FF - power off zz: 01 - mute; 00 - unmute zz: 00 - no signal, 01 - has signal																		
Query Screen Status	DD FF 00 06 C1 32 00 01 xx yy BB CC	DD FF 00 06 C1 32 00 01 01 F5 BB CC	AB AB 00 07 C1 32 00 01 xx zz yy CD CD zz: 00 - screen off; 01 - screen on eg: AB AB 00 07 C1 32 00 01 01 F5 CD CD																		
Query Source	DD FF 00 06 C1 1A 00 00 xx yy BB CC	DDFF0006C11A000001DCBBCC	AB AB 00 08 C1 1A 00 00 xx zz zz yy CD CD zz zz - source, refer to user menu for source definition																		
Query SW Version	DD FF 00 06 C1 1B 00 00 xx yy BB CC	DDFF0006C11B000001DDBBCC	AB AB 00 09 C1 1B 00 00 xx zz zz yy CD CD zz zz zz - Year Month Date																		
Query Backlight Brightness	DD FF 00 06 C1 3E 00 24 xx yy BB CC	DDFF0006C13E002401DCBBCC	AB AB 00 LL C1 3E 00 24 xx zz zz yy CD CD zz: 01 - bright, 02 - soft, 03 - auto adjust, 04 - stereo frequency conversion, 05 - Comfort frequency conversion, 06 - custom zz: when first zz is 06 custom, this byte means backlight brightness value: 0-30 LL: when first zz is zz, LL = 08, otherwise, LL = 07																		
Query Brightness	DD FF 00 06 C1 36 00 01 xx yy BB CC	DDFF0006C136000101F0BBCC	AB AB 00 07 C1 36 00 01 xx zz yy CD CD zz is the brightness value																		

Query Network Status	DD FF 00 06 C1 FF 00 16 xx yy BB CC	DFFF0006C1FF0016012FBCC	AB AB 00 07 C1 FF 00 16 xx zz yy CD CD zz: 00 - no network connection; 01 - network connected
Query Sound Mode	DD FF 00 06 C1 FF 00 02 xx yy BB CC	DFFF0006C1FF0002013BBCC	AB AB 00 07 C1 FF 00 02 xx zz yy CD CD zz = 00 - standard, 01 - music, 02 - news, 08 - movie, 10 - sports, 20 - custom, 30 - voice, 40 - meeting
Query AC Power On Status	DD FF 00 06 C1 FF 00 08 xx yy BB CC	DFFF0006C1FF00080131BBCC	AB AB 00 07 C1 FF 00 08 xx zz yy CD CD zz: 00 - power on; 01 - Last mode; 02 - standby
Query IP Address	DD FF 00 06 C1 1B 20 00 xx yy BB CC	DFFF0006C11B200001FDBCC	AB AB 00 16 C1 1B 20 00 xx zz ... zz yy CD CD zz zz zz zz - IP address zz zz zz zz - Subnet mask zz zz zz zz Gateway zz zz zz zz - DNS
Query Device Temperature	DD FF 00 06 C1 FE 00 00 xx yy BB CC	DFFF0006C1FE00000138BBCC	AB AB 00 07 C1 FE 00 00 xx zz yy CD CD zz: temperature in centigrade
Query Picture Mode	DD FF 00 06 C1 6D 00 00 xx yy BB CC	DD FF 00 06 C1 6D 00 00 64 CE BB CC	AB AB 00 07 C1 6D 00 00 xx zz yy CD CD zz: 00 – standard, 01 – bright, 06 – AI, 07 – user, 02 – soft, 03 – movie, 04 – text, 05 – game, 12- nature
Query USB Status	DD FF 00 06 C1 6E 00 00 xx yy BB CC	DD FF 00 06 C1 6E 00 00 64 CD BB CC	AB AB 00 07 C1 6E 00 00 xx zz yy CD CD zz: 00 - off, 01 - on
Query Eye Protection Mode	DD FF 00 06 C1 FF 00 1D xx yy BB CC	DFFF0006C1FF001D0124BBCC	AB AB 00 07 C1 FF 00 1D xx zz yy CD CD zz: 00 - Off; 01 - On
Query SN	DD FF 00 06 C1 FF 00 0B xx yy BB CC	DFFF0006C1FF000B0132BBCC	AB AB 00 1D C1 FF 00 0B xx zz...zz yy CD CD zz .. zz: 23 bytes serial number
Query Devicd ID	DD FF 00 06 C1 FF 00 0D xx yy BB CC	DFFF0006C1FF000D0134BBCC	AB AB 00 26 C1 FF 00 0D xx zz...zz yy CD CD zz .. zz: 32 bytes device ID
Query MAC Address	DD FF 00 06 C1 6C 00 00 xx yy BB CC	DFFF0006C16C000001AABBCC	AB AB 00 0C C1 6C 00 00 xx zz...zz yy CD CD zz .. zz: 6 bytes
Query volume	DD FF 00 06 C1 7D 00 00 xx yy BB CC	DD FF 00 06 C1 7D 00 00 64 DE BB CC	AB AB 00 07 C1 7D 00 00 xx zz yy CD CD zz: volume
Query Serial Port ID	DD FF 00 06 C1 1B 10 00 xx yy BB CC	DD FF 00 06 C1 1B 10 00 64 A8 BB CC	AB AB 00 06 C1 1B 10 00 xx zz yy CD CD zz: serial port ID. Settings -> signal manager -> serial port ID
Query brand	DD FF 00 06 C1 FE 00 01 xx yy BB CC	DD FF 00 06 C1 FE 00 01 64 5C BB CC	AB AB 00 06 C1 FE 00 01 xx zz...zz yy CD CD zz...zz: brand. ex: hisense (ASCII)

Query model	DD FF 00 06 C1 FE 00 02 xx yy BB CC	DD FF 00 06 C1 FE 00 02 64 5F BB CC	AB AB 00 06 C1 FE 00 02 xx zz...zz yy CD CD zz...zz: model name																								
Send Remote Controller Key Code	DD FF 00 08 C1 17 00 00 xx zz zz yy BB CC	ex: send menu key: zz zz = 00 00 DDFF0008C1170000010000DFBBCC zz zz = 00 00 - Menu; 00 01 - UP, 00 02 - DOWN, 00 03 - LEFT, 00 04 - RIGHT, 00 05 - OK, 00 06 - Return, 00 07 - Source	AB AB 00 08 C1 17 00 00 xx zz zz yy CD CD																								
Open Settings	DD FF 00 06 C1 41 00 00 xx yy BB CC	DDFF0006C14100000187BBCC	AB AB 00 06 C1 41 00 00 xx yy CD CD																								
Open Home	DD FF 00 06 C1 FF 00 1A xx yy BB CC	DDFF0006C1FF001A0123BBCC	AB AB 00 06 C1 FF 00 1A xx yy CD CD																								
Open CMS	DD FF 00 06 C1 FF 00 13 xx yy BB CC	DDFF0006C1FF0013012ABBCC	AB AB 00 06 C1 FF 00 13 xx yy CD CD																								
Open ScreenShare	DD FF 00 06 C1 43 00 00 xx yy BB CC	DDFF0006C14300000185BBCC	AB AB 00 06 C1 43 00 00 xx yy CD CD																								
Turn on Hotspot	DD FF 00 06 C1 44 00 00 xx yy BB CC	DDFF0006C14400000182BBCC	AB AB 00 06 C1 44 00 00 xx yy CD CD																								
Take Screenshot	DD FF 00 06 C1 4B 00 00 xx yy BB CC	DDFF0006C14B0000018DBBCC	AB AB 00 06 C1 4B 00 00 xx yy CD CD																								
Freeze Screen	DD FF 00 07 C1 0F 08 00 xx zz yy BB CC	DD FF 00 07 C1 0F 08 00 01 01 C1 BB CC zz = 01 - freeze; 00 – unfreeze	AB AB 00 07 C1 0F 08 00 xx zz yy CD CD																								
Query Max_Backlight	DD FF 00 06 C1 FE 00 04 xx yy BB CC	DD FF 00 06 C1 FE 00 04 01 50 6C BB CC Set the maximum brightness to 80.	AB AB 00 07 C1 FE 00 04 xx zz yy CD CD																								
Query Min_Backlight	DD FF 00 06 C1 FE 00 05 xx yy BB CC	DD FF 00 06 C1 FE 00 05 01 14 29 BB CC Set the minimum brightness to 20	AB AB 00 07 C1 FE 00 05 xx zz yy CD CD																								
Query Brightness_Ambient Light	DD FF 00 07 C1 FE 00 06 xx zz yy BB CC	<table border="1"> <thead> <tr> <th>zz</th> <th>Brightness_</th> </tr> </thead> <tbody> <tr><td>0x00</td><td>0</td></tr> <tr><td>0x01</td><td>10</td></tr> <tr><td>0x02</td><td>20</td></tr> <tr><td>0x03</td><td>30</td></tr> <tr><td>0x04</td><td>40</td></tr> <tr><td>0x05</td><td>50</td></tr> <tr><td>0x06</td><td>60</td></tr> <tr><td>0x07</td><td>70</td></tr> <tr><td>0x08</td><td>80</td></tr> <tr><td>0x09</td><td>90</td></tr> <tr><td>0x0A</td><td>100</td></tr> </tbody> </table>	zz	Brightness_	0x00	0	0x01	10	0x02	20	0x03	30	0x04	40	0x05	50	0x06	60	0x07	70	0x08	80	0x09	90	0x0A	100	AB AB 00 09 C1 FE 00 06 xx zz1 zz2 zz3 yy CD CD
zz	Brightness_																										
0x00	0																										
0x01	10																										
0x02	20																										
0x03	30																										
0x04	40																										
0x05	50																										
0x06	60																										
0x07	70																										
0x08	80																										
0x09	90																										
0x0A	100																										
Query All Ambient Light	DD FF 00 06 C1 FE 00 07 xx yy BB CC	DD FF 00 06 C1 FE 00 07 01 3F BB CC	AB AB 00 1C C1 FE 00 07 xx zz1 zz2 ... zz22 yy CD CD																								

Hisense

www.hisense-b2b.com