

# USER MANUAL

Read the manual carefully and ensure you have fully understood its contents before operating this device for the first time.





## Precautions for use

- During the use of the product, moisture may also cause a short-circuit inside the device.
- If the device experiences the following situations during use, please carry out dehumidification treatment:
  - If the usage environment exceeds the requirements for using the device, that is, the indoor temperature goes beyond the range of 0°C - 40°C and the humidity goes beyond the range of 10% - 80%.
  - The screen has not been used for more than 10 days.
- If the device is damaged due to the usage environment exceeding the product standards, the warranty service will not be provided.
- Even if the usage environment meets the product standards, the rapid inflow of external hot and humid air can still cause condensation on the device surface. In this case, you should wait for the device to dry completely.
- Condensation will occur if the surface temperature of the product is lower than the ambient air temperature, or if the product surface is cooled in the presence of hot and humid air.
- If condensation occurs on the product, it may lead to product malfunctions. In this case, the warranty service cannot be provided.
- Please do not let the air outlet of the air conditioner blow directly on the screen surface.
  - If the air outlet of the air conditioner blows directly on the screen surface, it may cause condensation on the screen surface.
  - If the air outlet of the air conditioner is too close to the screen, you can install a wind deflector as shown in the following figure to prevent the air from the air - conditioner outlet from affecting the screen.



## Safety Precautions

### Declaration

Any content and service accessed through this device shall be the property of the applicable third party and subject to protection by regulations and laws on copyright, patent, trademark and other intellectual property rights. No part of such content and service may be modified, duplicated, published, uploaded, distributed, translated, marketed, or used to make and distribute products derived from it without the prior permission of the content owner or service provider.

The manufacturer hereby declares explicitly that the manufacturer shall not be held liable for any guarantee and conditions implied related to this device and any content and service, including but not limited to warranty on marketability, satisfactory quality, fitness for a particular purpose, accuracy, quiet use and non-violation of any third party's rights. To the maximum extent permitted by applicable law, the manufacturer gives no guarantee on the accuracy, validity, timeliness, legitimacy and completeness of any content or service provided through this device, or the fitness of such device, content or service for your particular requirement, or the protection from interruption and error during operation of such device, content or service.

To the maximum extent permitted by applicable law, in any case, including fault or neglect, the manufacturer shall not be held liable for legal actions or indemnity obligation arising from any consequence as a result of or related to any information loaded in this device or use of such device, content or service by you or any third party .

Any content or service provided as it is together with this device shall be the property of the applicable third party, therefore Manufacturer gives no declaration or warranty on modification, suspension, cancellation, termination or abortion thereof, and shall not be held liable for legal actions or indemnity obligation arising thereof.

Manufacturer reserves the rights to restrict the use or access of certain content or service. As the contents and services are transmitted through third party's network and transmission facilities, Manufacturer undertakes no customer service thereof or the obligation for such customer service.

### Statement

- The pictures and instructions in this user manual are for reference only, and may be different from the actual product. Please refer to the actual product. (This statement is valid throughout the entire user manual.)
- Quality upgrades, product design and specifications are subject to change without notice.
- The software content service applicable to this product depends on the third party provider, and some software may not be used due to network, region, service cycle and other problems, which has nothing to do with the product quality. Please contact the third party provider for relevant details.



**For the first time installation, if the light board has been stored for more than 6 months (calculated from the date of manufacture) without installation, or if the vacuum packaging is found to be damaged and leaking air, the light board needs to be baked in an oven before installation. Bake COB products at 80°C for 48 hours and GOB products at 60°C for 48 hours. If the equipment is damaged due to the use environment exceeding the product standards, failure to dehumidify as required, or product condensation, etc., warranty services will not be provided.**



This symbol alerts user about the presence of a dangerous voltage not isolated inside the product which can be sufficiently powerful to constitute a risk of electrocution.



This symbol alerts user about the presence of important operating instructions and maintenance in the document enclosed in the package.



**ATTENTION**  
RISK OF ELECTRIC  
SHOCK



**Do not open the back cover.**  
In no case the user is allowed to operate inside the device. Only a qualified technician is entitled to operate.



AC voltage: This symbol indicates that the rated voltage marked with the symbol is AC voltage.



DC voltage: This symbol indicates that the rated voltage marked with the symbol is DC voltage.



Class I product: This symbol indicates that it requires a safety connection of protective earthing.

## Disposal of Used Electrical & Electronic Equipment



Packaging and electrical goods should be recycled appropriately, and not treated as household waste. Please dispose of this equipment at your applicable collection point for the recycling of electrical & electronic equipment waste. By ensuring the correct disposal of this product, you will help prevent potentially hazardous to the environment and to human health, which could otherwise be caused by unsuitable waste handling of this product. The recycling of materials will help conserve natural resources. Please do not therefore dispose of your old electrical and electronic equipment with your household waste. For more detailed information about recycling of this product, please contact your local city office, your household waste disposal service or the shop where you purchased the product.

## Important Notice

Paragraphs beginning with the symbol  indicate important instructions, tips or conditions for the following settings.



For your own safety and the optimal performance of your screen, ensure to read the safety instructions before performing any installation.

Compatibility with 3rd party products, software and services are not guaranteed. We cannot be held liable for any damage or loss suffered whilst operating, using or connecting to incompatible devices or apps.

The recording and playback of content on this or any other device may require permission from the owner of the copyright or other such rights in that content. It is your responsibility to ensure that your use of this or any other device complies with applicable copyright legislation in your country. Please refer to that legislation for more information on the relevant laws and regulations involved or contact the owner of the rights of the content you wish to record or playback.

**Read these instructions**

**Follow all instructions**

**Heed all warnings**

**Keep these instructions**

**All rights reserved.**

### WARNING

This product can expose you to chemicals including [Both Styrene and BPA] which are known to the State of California to Cause Cancer and Reproductive Harm. For more information go to [www.P65Warnings.ca.gov](http://www.P65Warnings.ca.gov).

## Safeguards

Please read the following safeguards for your device and retain for future reference. Always follow all warnings and instructions marked on the device.

### 1. A note about safety and operating instructions

Read and follow all safety and operating instructions, and retain them safely for future reference.

### 2. Heed Warnings

Adhere to all warnings on the appliance and in the operating instructions.

### 3. Cleaning

Unplug the device from the wall outlet before cleaning. Do not use liquid, abrasive, or aerosol cleaners. Cleaners can permanently damage the cabinet and screen. Use a lightly dampened cloth for cleaning.

### 4. Water and Moisture

Avoid dripping or splashing of liquids onto the product. Objects filled with liquids, such as vases, should not be placed on the product.

### 5. Ventilation

Slots and openings in the cabinet are provided for ventilation, to ensure reliable operation of the device and to protect it from overheating. Do not cover the ventilation openings in the cabinet and never place the set in a confined space such as built-in cabinet unless proper ventilation is provided. Leave a minimum 10cm gap all around the unit.

### 6. Power Source

This device should be operated only from the type of power source indicated on the marking label. If you are not sure of the type of power supplied to your home, consult your appliance dealer or local power company. If use the power source Less than or equal to AC 120V, the air switch is necessary. And the air switch current specifications are greater than 20A. The installation location is easy to operate and the power distribution box must be locked. Power and grounding requirements compliance professionals or consult your appliance dealer.

### 7. Power-Cord Protection

Power- supply cords should be routed so that they are not likely to be walked on or pinched by items placed upon or against them, paying particular attention to cords at plug, wall outlets, and the point where they exit from the device. Main plug is used as the disconnect device, the disconnect device shall remain readily operable.

### 8. Lightning

For added protection for this device during a lightning storm, or when it is left unattended and unused for long periods of time, unplug it from the wall outlet and disconnect the cable system. This will prevent damage to the device due to lightning or power-line surge.

### 9. Overloading

Do not overload wall outlets and extension cords as this can result in a risk of fire or electric shock.

### 10. Object and Liquid Entry

Never push objects of any kind into this device through openings as they may touch dangerous voltage points or short-out parts that could result in fire or electric shock. Never spill liquid of any kind on or into the device.

### 11. Servicing

Do not attempt to service this device yourself as opening or removing covers may expose you to dangerous voltage or other hazards. Refer all servicing to qualified service personnel.

### 12. Damage Requiring Service

Unplug the device from the wall outlet and refer servicing to qualified service personnel under the following conditions:

- (a) When the power - supply cord or plug is damaged.
- (b) If liquid has been spilled, or objects have fallen into the device.
- (c) If the device has been exposed to rain or water.

(d) If the device does not operate normally by following the operating instructions. Adjust only that are covered by the operating instructions as an improper adjustment of other controls may result in damage and will often require extensive work by a qualified technician to restore the device to its normal operation.

(e) If the device has been dropped or the cabinet has been damaged.

(f) When the device exhibits a distinct change in performance - this indicates a need for service.

### 13. Replacement Parts

When replacement parts are required, be sure the service technician has used replacement parts specified by the manufacturer or have the same characteristics as the original part. Unauthorized substitutions may result in fire, electric shock or other hazards.

### 14. Safety Check

Upon completion of any service or repair to the device, ask the service technician to perform safety checks to determine that the device is in safe operating condition.

### 15. Heat

The product should be situated away from heat sources such as radiators, heat registers, stoves, or other products (including amplifiers) that produce heat.

### 16. Fire

The product should be situated away from naked flame sources such as lighted candle.

### 17. Off-gassing

The device smells of plastic is normal and will dissipate over time.

### 18. Installation

(a) Professionals carry out installation and removal, and execute safety inspection after installation.

(b) The installed power cord should be hidden or protected to avoid tripping, crushing cause damage.

(c) The LED display can be connected to a maximum of six by six cabinets.

### 19. Use environment requirements:

(a) indoor.

(b) The operation ambient temperature should be kept between 0°C and 40°C.

(c) The operation ambient humidity should be kept between 10% and 90%RH (no frost).

(d) waterproof.

(e) The operation altitude is less than 5 km.

### 20. Daily use

(a) Check the screen whether missing or not before powering on.

(b) Turn off the power when the LED display is not in use.



Incorrect replacement of the battery may lead to the risk, including the replacement of another similar or the same type. Do not expose batteries to heat such as sun or fire or something like that.



The device should not be exposed to dripping and spraying and it cannot be placed under objects filled with liquids.



Main plug is used as the disconnect device, the disconnect device shall remain ready for operating.



Apparatus with CLASS I construction shall be connected to a MAINS socket outlet with a protective earthing connection.



# CONTENTS

Accessories List.....	1
Remote Control .....	2
Front Panel & Interface.....	4
Making Connections.....	5
Initial Start.....	8
Use of Menu .....	11
Serial Protocol .....	15
Other Information.....	18
Trouble Shooting .....	19
Specifications .....	21
Installation Guide .....	23
Maintenance .....	38



## 1 Accessories List

Remote Control × 1

User Manual × 1

Network Port to DB9 Cable × 1

NFC Module × 1

Battery × 2

OPS Signal Cable × 1

### NOTE

- The accessories may be different from the list above due to different models, countries / regions, please refer to the actual accessory bag.
- AC power cables may not be provided depending on the model. Contact the dealer from whom you purchased the product if you want to be purchased separately.

# 2

## Remote Control

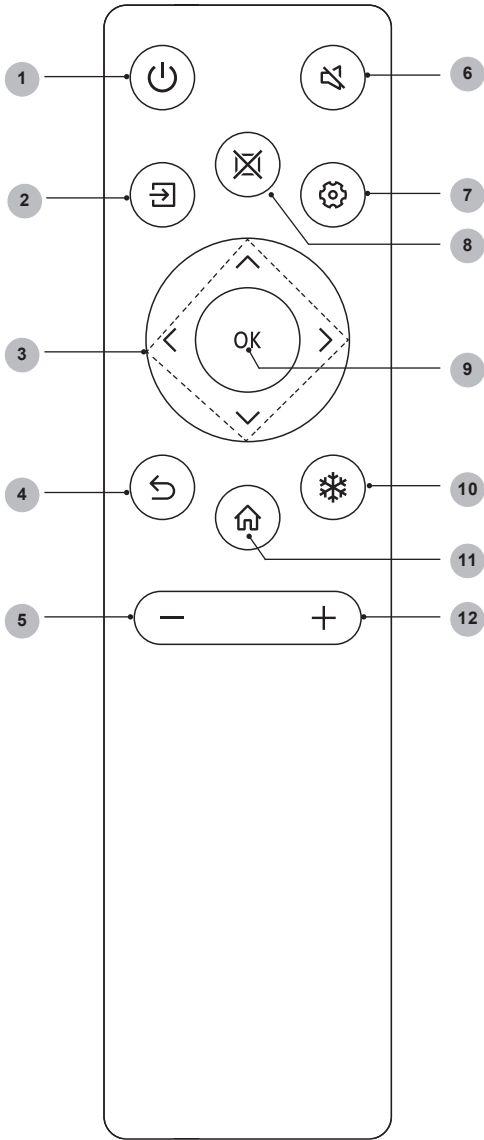

Number	Description
1	Power Enter/exit standby
2	Source Switching signal source
3	^ / v Move focus up/down < / > Move focus left/right
4	Back Back to previous menu
5	Volume down (-)
6	Mute Activate/exit mute state
7	Setting Open the Settings menu
8	Blank Switch On/Off screen
9	OK Confirm operation
10	Freeze On/Off Screen freeze and sound mute
11	Home Enter home page
12	Volume up (+)

## Battery replacement method

1. Disconnect the battery cover from the remote control at the battery cover buckle and open the battery cover.
2. Insert two AAA 1.5V alkaline batteries. Note that the positive (+) and negative (-) terminals of the batteries must match the positive (+) and negative (-) terminals in the battery case.
3. Close the battery cover from top to bottom until it is fully aligned with the remote control.

## Precautions

1. If the remote control is not working properly, is unstable, or can't control the device, please replace the batteries.
2. If you do not use the remote control for a long time or the battery is exhausted, remove the battery. (Waste batteries pollute the environment and must be handled properly.)
3. In order to achieve the best remote control effect, please point the black launch window on the back of the remote control at the indicator light of the device.
4. Discard batteries in a designated disposal area. Do not throw them into a fire.
5. Remove old batteries immediately to prevent them from leaking into the battery compartment.
6. Battery chemicals can cause a rash. If the batteries leak, clean the battery compartment with a cloth. If chemicals touch your skin then wash it immediately.
7. Do not mix old and new batteries.
8. Do not mix alkaline, standard (carbon-zinc) or rechargeable (NiCd, NiMH, etc.) batteries.
9. Do not continue using the remote if it gets warm or hot.
10. If any of these issues occur, call our Support Center immediately on the support website.

## Effective range

1. Remote control distance: The distance from the front of the remote control is valid within 8m.
2. Remote control angle: With the remote control receiving window of the device as the apex, the angle in horizontal direction at the distance of 6m is at least  $\pm 30^\circ$ , and the angle in vertical direction is at least  $\pm 15^\circ$ .

# 3

## Front Panel & Interface

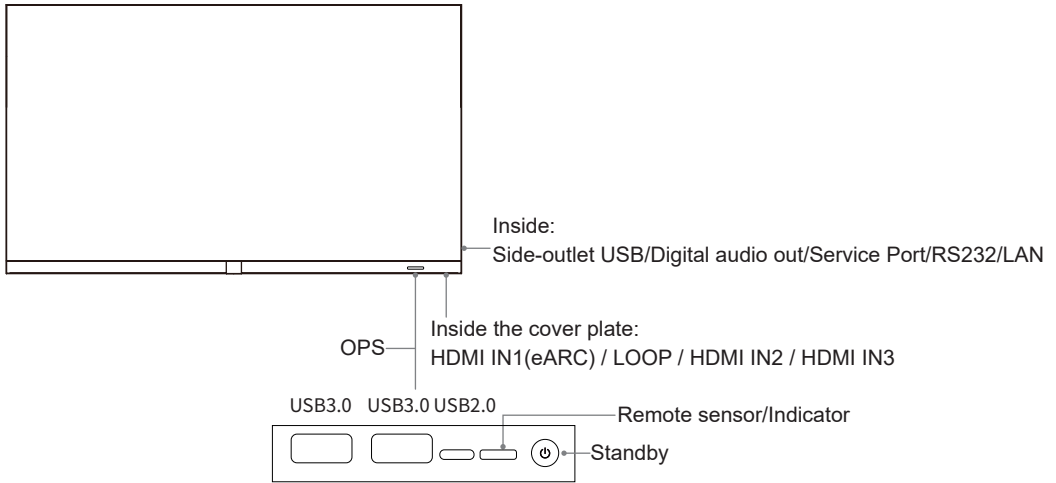

Item	Description
Standby button	When the device is on, short press the button to turn off the screen, long press the button to go into standby mode. When the screen is off, press the button to open the screen, and when the device is on standby, press the button to start.
Indicator	The indicator light displays the state of power on or standby: <ul style="list-style-type: none"> <li>• When the device is on, the light is blue.</li> <li>• When standby, the light is red.</li> <li>• When the device with OPS module is turned on, the light is green.</li> </ul>
Remote sensor	Receive the signals emitted by the remote control.
USB	Connect USB devices such as hard disks, keyboard, mouse, etc.
HDMI IN	The HDMI interfaces allow digital audio and video signals to be transmitted using a single cable without compression. HDMI supports multi-channel digital audio, and can be connected to external devices with HDMI port.
LOOP	The images from the HDMI IN2 port support synchronous output and can be output to other display devices via the LOOP port.
DIGITAL AUDIO OUT	Connect to power amplifier via optical port, then connect power amplifier to speaker.
LAN	LAN port (RJ45 Ethernet), supports TCP/IP communication.
OPS SLOT	Slot for adding OPS module.
RS232	Serial interface, used for mutual transfer of data between devices.
Service Port (3.5mm)	Used exclusively for factory debugging and maintenance. Do not use this interface.

### NOTE

- Some external devices may fail to connect to this device due to individual differences. If you encounter this situation, please replace the signal cable with a suitable one or add an adapter cable that matches the port.

# 4 Making Connections

## ▶ Connect to USB interface device

The total current of all the USB output ports of the device when connected to external devices at the same time mustn't exceed 2300mA, or else the device failure caused by over current isn't covered by the warranty.

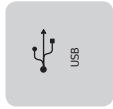

Device port

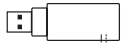

External device

### NOTE

This device is connected to wireless keyboard and mouse devices. If there is any insensitivity phenomenon during use, you can try to change the wireless receiver to another USB port, or use a USB extension cord to connect the wireless receiver in order to enhance the receiving range.

## ▶ Connect to HDMI input

Connect the HDMI input connector of the device to the HDMI output port of an external device.



Device port

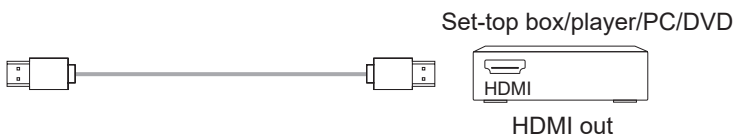

### NOTE

The supported signal formats of the HDMI port refer to Specifications.

## ▶ Connect to external audio device

DIGITAL AUDIO OUT: connect to power amplifier via optical port, then connect power amplifier to speaker.



Device port

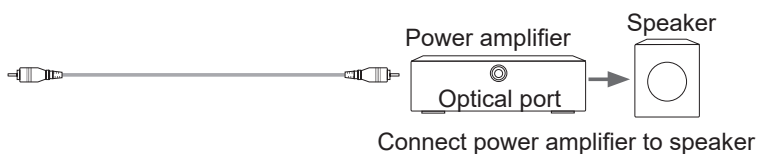

## ► Connect to network

Enter the **Settings** menu and select the **Network** item.

### ● **WIFI**

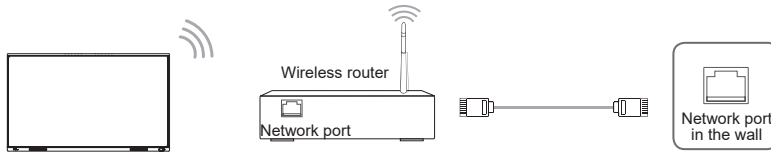

The device can receive network signals directly through Wireless router

- The available wireless network list is automatically displayed when the WIFI is selected.
- Select an available network, enter the password, and tap Connect. If the selected network is not encrypted, you can connect directly.
- If the network you want to connect to is not displayed in the list, tap Refresh to display more networks. If the network you want is still not displayed after this operation, tap Add Network and enter the network name manually, select the corresponding encryption method according to router settings, enter the password, and tap Confirm.

### ● **Ethernet**

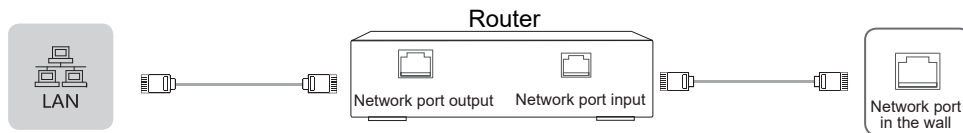

Device port

#### • **Ethernet: auto**

The device automatically obtains an IP address and connects to the network. If failure, repeat the operation again or choose Ethernet: manual.

#### • **Ethernet: manual**

Manually enter the IP Address, Subnet Mask, DNS Server and Gateway.

## ► Connect to the OPS interface device

OPS (Open Pluggable Specification) is the interface specification developed by INTEL which is applicable to embedded computer module products. With this interface, the screen can be connected to the device in compliance with OPS interface specification, which is short for OPS module. You can buy the module and conduct secondary development in accordance with your requirements. Recommended adaptable OPS modules is S02EMS5C821C;

This product can provide the OPS module with 19V±0.5V (3.4A MAX) power supply.

### 📌 **NOTE**

It is recommended to choose and purchase OPS computers with the i3/i5/i7 latest generation processor, 4G memory, 128 GB solid state drive or above.

You should purchase the OPS module which is applicable to the size of the device OPS. The size of OPS refers to the following figure:

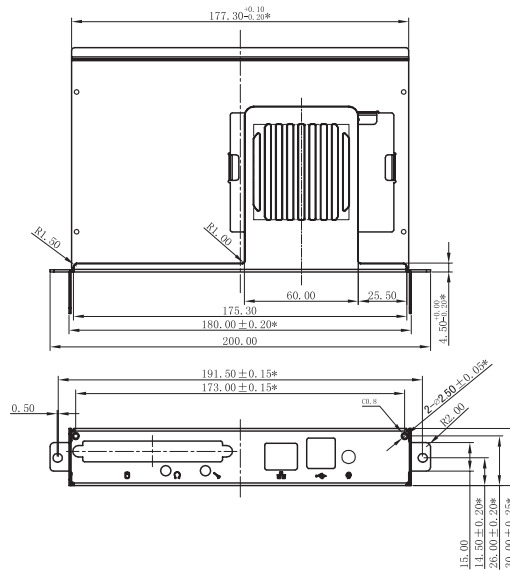

### • Switching on/off the OPS

After inserting OPS to the device, you turn on the device, change the signal source to enter OPS and stays on the OPS system interface. When you turn off the device, you should use the standby button to go into standby mode, the OPS module is switched off, and then you shut off the device.

#### [ Description ]

- Powering off the unit directly may damage the hard disk of the OPS module. It is strongly recommended that you use the following two methods to shut down:
  - 1 When switching off the unit, please use the remote control to make the unit be in a standby mode. At this time, the OPS module will be shut down normally, followed by the power cutoff.
  - 2 Switch off OPS manually. Switch off the computer switch in the setup menu, or use the start menu in the computer.
- When OPS is illegally shut down due to the direct power cutoff of this unit, the WINDOWS fix interface will appear. At this time, the USB keyboard or wireless key board should be used to confirm the fix. After the fix is complete, the system will continue to enter the system.

### OPS Setup

For a brand new OPS module, there is need to enter the BIOS and set the module. Follow the prompts to enter the BIOS option during the OPS boot process, and do the followings in Advance:

- 1 Set USB Keyboard/Mouse Wakeup is set as Enabled;
- 2 Restore AC Power Loss is set as Power Off
- 3 Enter the power options in the WINDOWS control panel, set the display off time and sleep time to “Never” respectively, and define the function of the power button as “Shutdown”.

#### [ Description ]

- If the OPS module enters the off state and there is no any operation taken on the computer for a long time, the unit will enter the standby state. If there is need to use the OPS, restart the computer.

# 5 Initial Start

## Switching on/off

- Connect the power cord of the device to a 220-240V AC outlet.
- Press the standby button [⏻] on the remote control in the power on state to switch the device to standby; to resume normal watch, simply press the standby button [⏻] on the remote control again.
- To turn off the device, press the power switch or Unplug the Power cord.

## NOTE

- When the AC power is turned off, wait at least 1 minute before turning it on again in order to prevent problems of the device.

## Turning the device on for the First Time

1. The first time you turn the device on, it will go straight into the Installation Guide.
2. Press the [^ / v / < / >] buttons to navigate the menu and change the settings. Press the [OK] button to confirm.

<b>Language</b>	Please set the system language
<b>Time zone setting</b>	Please select time zone.
<b>EULA</b>	Please accept the END USER LICENSE AGREEMENT.
<b>Wi-Fi setting</b>	For better value-added services, please use the Internet for your first connection. Press Back on the remote to exit.

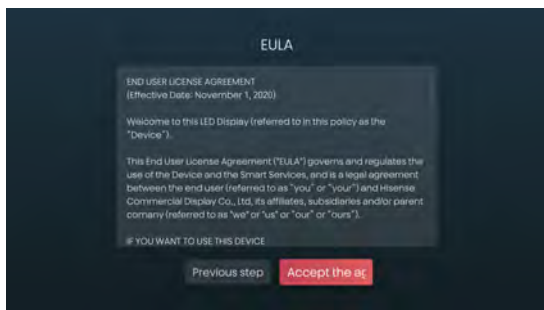
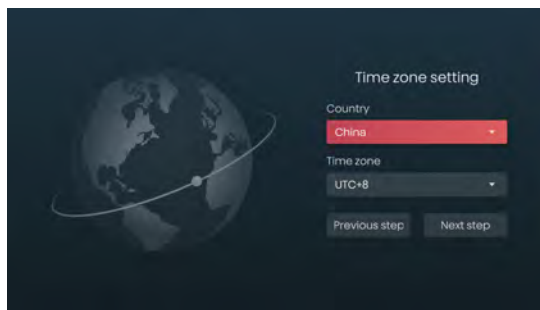
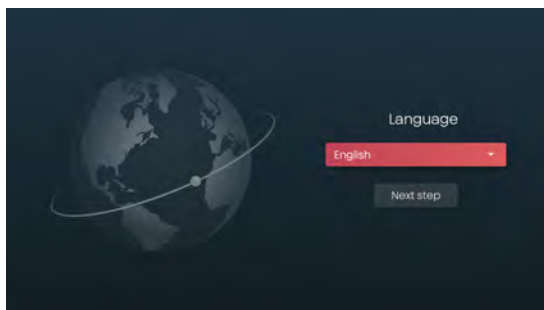

## NOTE

- Pictures are only for reference and may be different from the actual product.

## App

- Choose the More Apps icon to select Application

**NOTE:** App icons may change according to different needs.

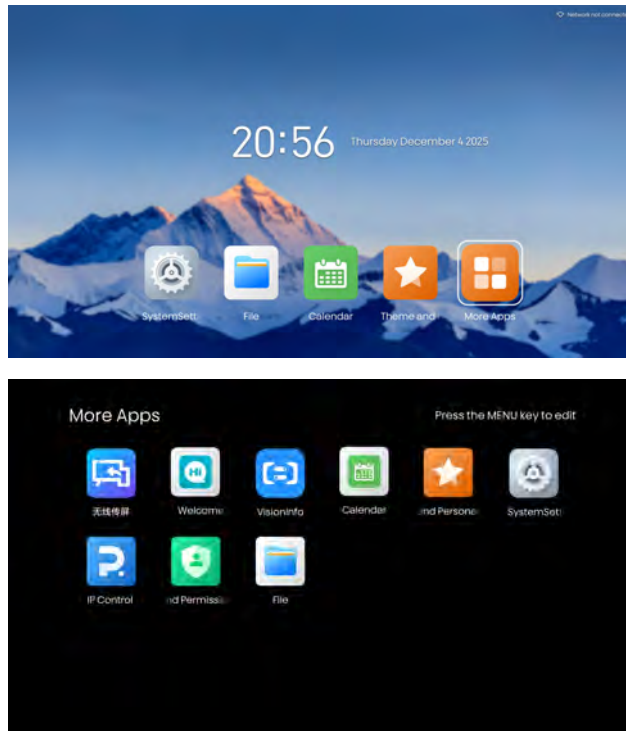

## ScreenShare

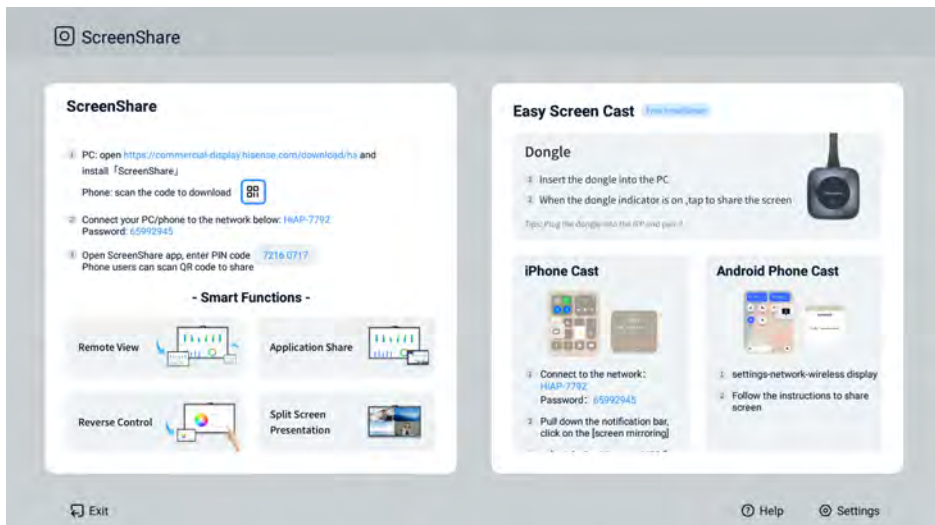

## ScreenShare

1. PC: open the official website of Hisense Commercial Display to install screenshare app.  
Phone: scan the QR code to download.
2. Connect your PC/phone to the specified network.
3. Open ScreenShare app, enter PIN code. Phone users can scan QR code to share.

- Easy Screen Cast

- (1) Dongle

- Insert the dongle into the PC. When the dongle indicator is on, tap to share the screen.

- Tips: plug the dongle into the IFP and pair it.

- (2) Phone Cast

- Connect to the wireless network. Follow the instructions to complete the casting function.

Main functions of the mobile terminal: File transfer, remote control, screen mirroring, etc.;

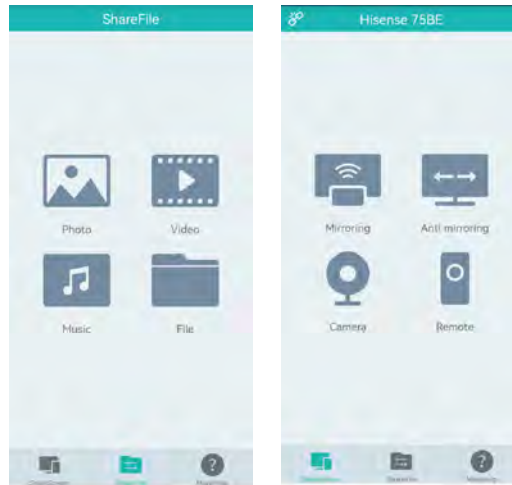

## ❏ NFC Tag

1. Open Screen Share APP.
2. Reference the Hisense Screen Share download ScreenShare APP.
3. Run ScreenShare APP on your mobile phone. Scan the QR code ensure the app and mobile phone connection successful. Click more help menu, then click creat NFC tag menu.
4. The back of the mobile phone close to the NFC tag. It will hints write successful finally. Exit the current action page.
5. Then run ScreenShare APP, the back of the mobile phone close to the NFC tag, you can run the ScreenShare function.



## ❏ NOTES

- Above operation you must ensure that the set and the phone are in the same network.
- NFC tag can be pasted on non-metallic position, such as coffee tables, sofas, TV cabinets, remote controls, etc.

# 6

## Use of Menu

### NOTE

- Pictures are only for reference and may be different from the actual product.
- Parts of the software function changes with the system upgrade.

### Network

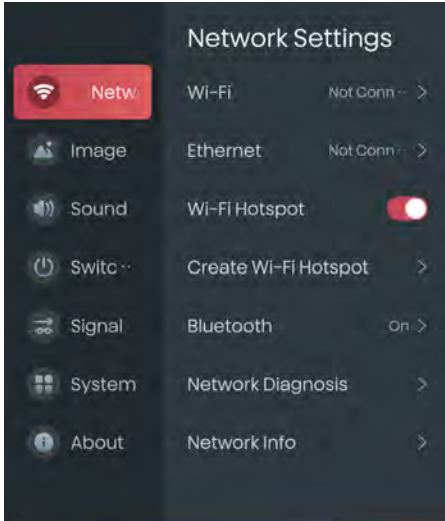

- **Wi-Fi:** Switch on the wireless network, display the connection status of the wireless network and the list of available networks. You can choose to refresh or manually add networks that do not appear in the list.
- **Ethernet:** Display the connection status of the wired network. You can set to obtain IP automatically and input IP manually.
- **Wi-Fi Hotspot:** Switch on or off, and on-by-default.
- **Create Wi-Fi Hotspot:** You can set up a Wi-Fi hotspot, defining Wi-Fi Name/Wi-Fi Password/Encryption/Channel. Certain channels may be invalid (depending on the channel range of the country/region).
- **Bluetooth:** Manage Bluetooth and devices.
- **Network Diagnosis:** Test and diagnose the connection status of the current network.
- **Network Info:** You can view network details.

### Image

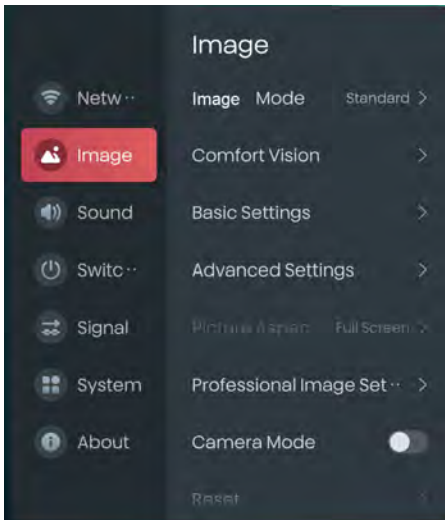

- **Image Mode:** Select the appropriate picture effect according to the content you are watching.
- **Comfort Vision:** Including LED Brightness Level, Smart Backlight, and Eyesheild Mode.
  - 1) LED Brightness Level: Select this function to enter user mode 1-8 brightness adjustment.
  - 2) Smart Backlight: Switch on or off, and on-by-default.
  - 3) Eyesheild Mode: You can select Off, Low, Medium, High.
- **Basic Settings:** Including Brightness, Contrast, Saturation, and Sharpness.
  - 1) Brightness: 0-100
  - 2) Contrast: 0-100
  - 3) Saturation: 0-100
  - 4) Sharpness: 0-20
- **Advanced Settings:** Including MEMC, Dynamic Contrast, AI Contrast, AI Depth, Black Gain, Precision Detail, Color Enhance, AI SR, Decontour, and Noise Reduction.
  - 1) MEMC: You can select Off, Clear, Standard, Smooth. Smooth by default.
  - 2) Dynamic Contrast: You can select Off, Low, Medium, High.
  - 3) AI Contrast: You can select Off, Low, Medium, High.
  - 4) AI Depth: Switch on or off.

- 5) Black Gain: 0-20
- 6) Precision Detail: Switch on or off.
- 7) Color Enhance: Switch on or off.
- 8) AI SR: 0-5
- 9) Decontour: You can select Off, Low, Medium, High.
- 10) Noise Reduction: You can select Off, Low, Medium, High.
- **Picture Aspect Ratio:** You can select Standard, 1:1, Full screen, ZOOM. Standard by default.
- **Professional Image Settings:** Including Dynamic Range, HDR Tone Mapping, Gamma, Gamma Adjustment, Color Temp, White Balance, Color Space, Color Adjustment.
  - 1) Dynamic Range: You can select Auto, All, Limited.
  - 2) HDR Tone Mapping: You can select Dynamic, Standard, Bright.
  - 3) Gamma: You can select 1.8, 2.2, 2.5, S Gamma, DCIOM, PQ, HLG, auto. 2.2 by default.
  - 4) Gamma Adjustment: You can adjust Gamma Control Point and Gain.
  - 5) Color Temp: Selectable 2000K, 3000K, 4000K, 5000K, 6000K, 6500K, 7000K, 7500K, 8000K, 9000K, 9300K.
  - 6) White Balance: Red gain, green gain, blue gain, red Offset, green Offset, blue Offset can be selected, the adjustment range (-30-----+30), the default is 0.
  - 7) Color Space: You can select Auto, BT.709, BT.2020, DCI-P3, Adobe RGB, Native.
  - 8) Color Adjustment: Red, Green, Blue, Cyan, Yellow, Purple, Skin color can be selected. Adjustment range (-15 ----- + 15), default as 0.
- **Camera Mode:** When turned on, start the "Scan Pattern" function; You can choose to turn it on, off, and off by default.
- **Reset:** Reset all changes in image settings to default values.

## ❏ Sound

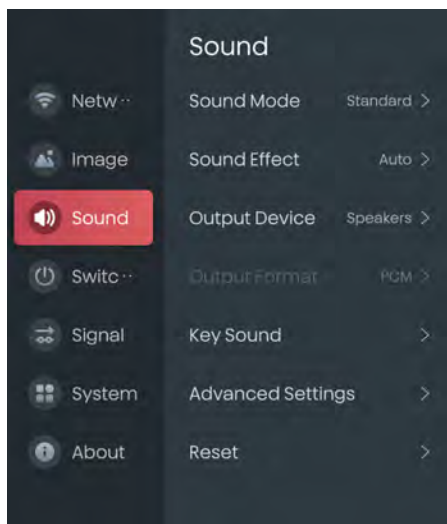

- **Sound Mode:** Select the appropriate sound effect according to the content you are watching. You can select Standard, Sports, Cinema, Music, and default Standard.
- **Sound Effect:** Select sound effect, and default Auto.
- **Output Device:** Select the device or external speakers as the sound output device.
- **Output Format:** Select the audio output format of the external device. You can select Auto, PCM, Pass Through, and the default is PCM .
- **Key Sound:** You can select Key Sound Switch and Key Sound Select.
- **Advanced Settings:** Further adjust parameters such as Equalizer, Balance, Audio Delay and Auto Volume, Independent Volume, AI Voice.
  - 1) Balance: Selectable (-10--10), default is 0.
  - 2) Equalizer: 100Hz, 250Hz, 600Hz, 1KHz, 2.5KHz, 6KHz, 10KHz can be selected, the adjustment range is -10--10, and the default is 0.
  - 3) Audio Delay: Selectable (-10--10), default is 0.
  - 4) Auto Volume: Selectable (-10 to 10), the default is 0.
  - 5) Independent Volume: Switch on or off, and on-by-default.
  - 6) AI Voice: You can select Off, Clear Voice High, Clear Voice Middle, Voice Weakening Middle, Voice Weakening High.
- **Reset:** Reset all changes in the sound settings to default values.

## Switch on/off

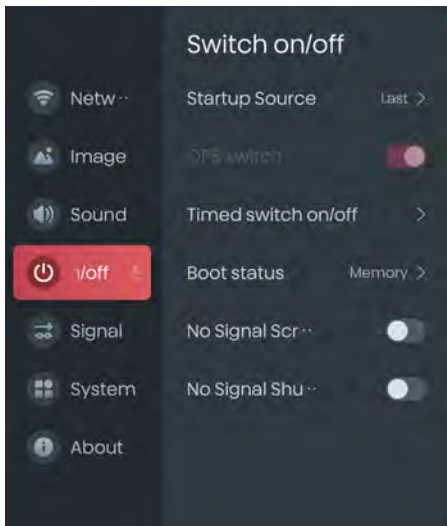

- **Startup Source:** You can select Last, Launcher, HDMI1, HDMI2, HDMI3, OPS, and the default is Last.
- **OPS switch:** Switch on or off, and off-by-default.
- **Timed switch on/off:** You can set the fixed Boot/Shutdown/Screen On/Screen Off/Signal Source/Freeze/Unfreeze time, and it will be commenced automatically when the time is up.
- **Boot status:** The boot status can be set to power on, standby or memory. On-by-default
- **No Signal Screen Rest:** When the No Signal Screen Off function is turned on, the screen display is turned off after the No Signal input lasts for a few minutes.
- **No Signal Shutdown:** When the No Signal standby function is turned on, the no-signal input lasts for a few minutes before the display enters standby mode.

## Signal

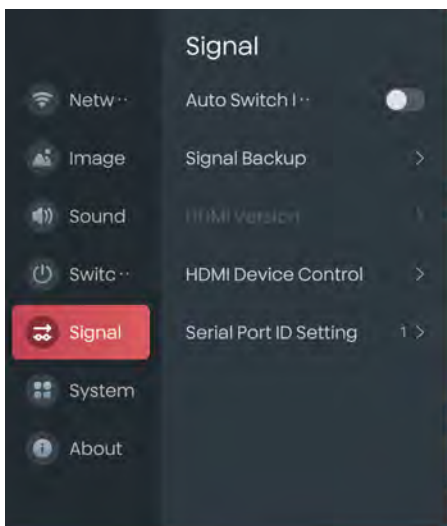

- **Auto Switch Input:** Switch on or off, and off-by-default.
- **Signal Backup:** Switch on or off, and off-by-default.
- **HDMI Version:** You can select HDMI Standard, HDMI Enhanced, and the default is HDMI Enhanced.
- **HDMI Device Control:** You can enable HDMI-CEC control with connected devices
- **Serial Port ID Setting:** Set the value of serial port id.

## System Settings

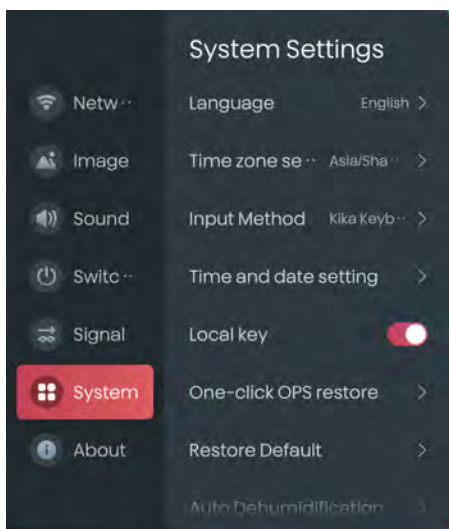

- **Language:** Select menu language as Chinese/English/Spanish/French/German/Italian/Polish/Arabic/Russian.
- **Time zone setting:** Set the current time zone, which can be selected by the user according to the embedded region.
- **Input Method:** Switch the input method. The default input method is Kika.
- **Time and date setting:** Set the date and time, you can select Network sync on / Network sync off /Date / Time.
- **Local key:** Switch on or off, and on-by-default.
- **One-click OPS restore:** Enables forced system recovery of OPS.
- **Restore Default:** Reset all changes in the system settings to the default values.
- **Auto Dehumidification:** When it is switched on, the Automatic Dehumidification will be activated. Set the backlight to 8, display 12 gray scale test cards, each for 2 hours, continuously for 24 hours. After 24 hours of playback, the system will return to original state.
- **Wake-on-LAN:** After switched, you can wake the TV via a wired network. You can choose ON or OFF, the default is OFF.

## About

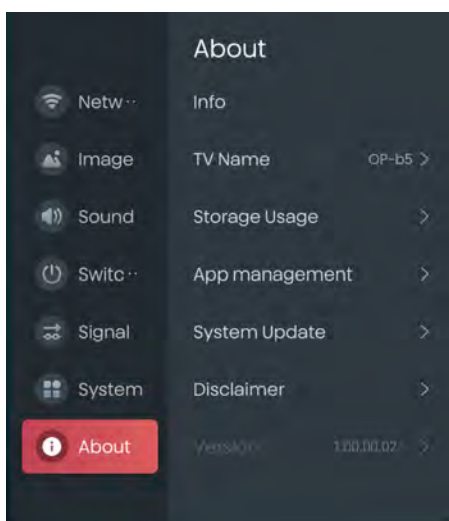

- **Info:** Including TV Name/Serial Number/Chip ID/Device ID/Software Version/Camera Firmware Version/Memory Info/Ethernet MAC Address/Wi-Fi MAC Address.
- **TV Name:** Select or customize the local name to facilitate the discovery of devices during Bluetooth pairing, screen projection and other operations.
- **Storage Usage:** Display system disk information and USB flash drive disk information.
- **App Management:** Manage local application software.
- **System Update:** Check for Updates.
- **Disclaimer:** Display the local service agreement and disclaimer.
- **Version:** Display Setting Version.

# 7

## Serial Protocol

### Serial port status

The device can receive the serial port command sent by the external controller or OPS of the device. Refer to the following table for the specific command protocol:

1. Baud rate: 9600 2. Control section: PC → The device 3. Response section: TV → PC

		Header		Length		Command				Monitor ID	DaTa	Checksum	End		
Power on	PC→TV	DD	FF	00	08	C1	15	00	00	01	BB BB	XX	BB	CC	
	TV→PC	AB	AB	00	08	C1	15	00	00	01	BB BB	XX	CD	CD	
Power off	PC→TV	DD	FF	00	08	C1	15	00	00	01	AA AA	XX	BB	CC	
	TV→PC	AB	AB	00	08	C1	15	00	00	01	AA AA	XX	CD	CD	
Screen on/off	Screen on	PC→TV	DD	FF	00	07	C1	31	00	00	01	01	XX	BB	CC
		TV→PC	AB	AB	00	07	C1	31	00	00	01	01	XX	CD	CD
	Screen off	PC→TV	DD	FF	00	07	C1	31	00	00	01	00	XX	BB	CC
		TV→PC	AB	AB	00	07	C1	31	00	00	01	00	XX	CD	CD
Reboot	PC→TV	DD	FF	00	06	C1	1E	00	00	01		XX	BB	CC	
	TV→PC	AB	AB	00	06	C1	1E	00	00	01		XX	CD	CD	
HDMI1 Input	PC→TV	DD	FF	00	07	C1	08	00	00	01	0E	C1	BB	CC	
	TV→PC	AB	AB	00	07	C1	08	00	00	01	0E	XX	CD	CD	
HDMI2 Input	PC→TV	DD	FF	00	07	C1	08	00	00	01	0F	C0	BB	CC	
	TV→PC	AB	AB	00	07	C1	08	00	00	01	0F	XX	CD	CD	
HDMI3 Input	PC→TV	DD	FF	00	07	C1	08	00	00	01	0C	C3	BB	CC	
	TV→PC	AB	AB	00	07	C1	08	00	00	01	0C	XX	CD	CD	
OPS Input	PC→TV	DD	FF	00	07	C1	08	00	00	01	0D	C2	BB	CC	
	TV→PC	AB	AB	00	07	C1	08	00	00	01	0D	XX	CD	CD	
Set Volume	PC→TV	DD	FF	00	07	C1	27	00	00	01	zz	XX	BB	CC	
	TV→PC	AB	AB	00	07	C1	27	00	00	01	zz	XX	CD	CD	

#### [NOTE]

- Length is the number of bytes of Command, Data and Checksum.
- Checksum is XOR of Length, Command, Monitor ID and Data.
- Set Volume data zz: volume range 0-100.

## IP Control Function

The IP Control function supports device local area network (LAN) deployment. The server and client must be in the same LAN. The IP control software acts as a server, supporting the TCP/IP network protocol and using ASCII string command format.

### Key Information About LAN Control:

- When controlling via LAN, the command content is directly sent in ASCII format. Unlike RS-232, which uses HEX codes, LAN control sends the same command structure using ASCII characters. This makes it easier to input and send commands over the network, offering a more straightforward implementation for various devices or software.
- LAN control commands are plain text (ASCII), simplifying the communication process. This means commands are easier to read and input compared to the binary HEX format used in RS-232 communication.

### Operation steps are as below:

1. Open the IP Control App

Start the "IP Control" from Apps on the monitor. Open the APK and show as below.

2. IP Address Set

IP Address (192.168.1.2) cannot be edited on the App. It needs to be edited via the setting menu on the monitor.

3. Set Port Number

The default port number is 8000. If port 8000 is occupied, please change the port (5000-12000).

4. Start the IP Control (Server)

Click "Start" Button, it will show "Stop"; Click "Stop" Button, it will show "Start".

5. Client App Connect to IP Control (Server)

You can use the Net Assist software. Select "TCP Client" from the Protocol on the setting, and set the server IP and server port. Finally, click the connect button. Please refer to the picture as below.

6. Send Command

Connect successfully, you can input the hex string command and click "Send" button.

For example:

Mute Control Command - Mute ON  
DDFF0007C1260000101E0BBCC

Note that: IP Control Command is the same with the RS232 Command. Command format refer to User Manual.

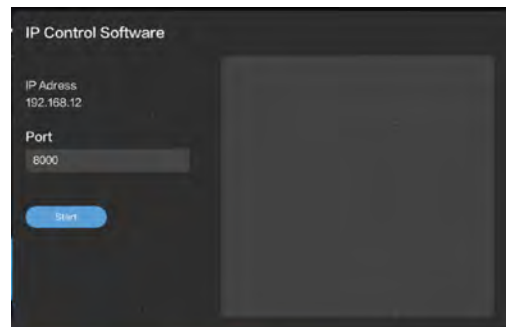

## Wake on Lan command

Wake On Command (Only Support Wired Network) need Wake on Lan software or send command according to the magic packet format.

Wake On Lan software wake up steps are as follows:

1. Switch on "Wake-on LAN", Setting->Switch on/off->Wake-on LAN.
2. Make sure the monitor and PC are in the same Lan, and the monitor connect with wire.
3. Remember the wired MAC, IP address, Subnet Mask and the port number(IP control port).
4. Make sure IP Control working well.
5. Open Wake on Lan software, input the mac, IP, subnet mask and port, then click "Wake Up", the monitor will be waked up.

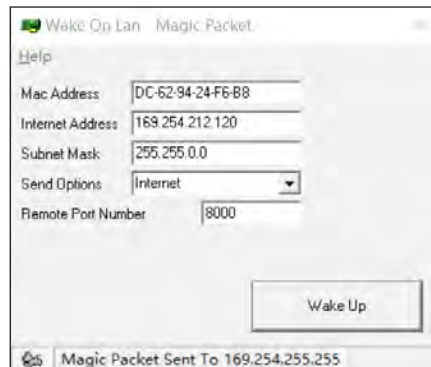

# 8

## Other Information

### Recycling/Licenses

WEEE (Waste Electronic Electric Equipment)

European Directive 2012/19/EU



This symbol on the product or on its packaging indicates that this product must not be disposed of with your household waste. Instead, it is your responsibility to dispose of your waste equipment by handing it over to a designated collection point for the recycling of waste electrical and electronic equipment.

The separate collection and recycling of your waste equipment at the time of disposal will help to conserve natural resources and ensure that it is recycled in a manner that protects human health and the environment. For more information about where you can drop off your waste equipment for recycling, please contact your local city office, your household waste disposal service or the shop where you purchased the product.

### Batteries



In accordance with the Battery Directive, used batteries should not be disposed of in the domestic waste. Dispose your batteries in the collection containers specific for this purpose in retail stores.

### ROHS (Restriction of Hazardous Substance)

European Directive 2011/65/EU



This European directive limits the use of dangerous and hazardous substances which are difficult to recycle.

This allows recycling easily the EEE and contributes to the safeguard of the environment.

Substances included in this product match to the RoHS directive.



Dolby, Dolby Vision, Dolby Atmos, and the double-D symbol are registered trademarks of Dolby Laboratories Licensing Corporation. Dolby Vision IQ is a trademark of Dolby Laboratories Licensing Corporation. Manufactured under license from Dolby Laboratories. Confidential unpublished works. Copyright © 2012–2024 Dolby Laboratories. All rights reserved.



Manufactured under license from DTS, Inc. and/or its affiliates. For patents, see <https://xperi.com/dts-patents/>. DTS, the DTS logo, DTS:X, the DTS:X logo, Virtual:X, and the DTS Virtual:X logo are trademarks or registered trademarks of DTS, Inc. and/or its affiliates in the U.S. and/or other countries. © DTS, Inc. and/or its affiliates. All rights reserved.

EU importer: Gorenje gospodinjski aparati, d.o.o.

ADD: Partizanska cesta 12, 3320 Velenje Slovenija

UK importer: Alltrade Ltd.

ADD: Sussex House Business Park, 274 Old Shoreham Road, BRIGHTON & HOVE, BN3 7EU

# 9

## Trouble Shooting

Before preparing for repair, check according to the table below to see if you can find the cause of the problem. If you strictly follow the instructions but still can't resolve the problem, you can turn to professional servicemen for help.

Problem	Solution
No sound or picture	<ul style="list-style-type: none"> <li>•Check if the power cord is connected to the wall outlet, and if the wall outlet is energized.</li> <li>•Check if you have pressed the Power button or Standby button.</li> <li>•Check the volume.</li> </ul>
Sound and picture are disturbed	<ul style="list-style-type: none"> <li>•Try to find the appliance that affects the LCD monitor and keep it away.</li> <li>•Try plugging the LCD monitor's power plug into another outlet.</li> </ul>
The screen cannot be powered on or the power indicator light is off.	<ul style="list-style-type: none"> <li>•Check whether the power supply is connected.</li> <li>•Check whether the power supply plug is properly connected.</li> <li>•Check whether the power outlet has electricity.</li> <li>•Check whether the AC switch is enabled.</li> <li>•Press the reset switch and start the system again.</li> </ul>
The unit turns off unexpectedly.	<ul style="list-style-type: none"> <li>•Check whether standby mode is enabled.</li> <li>•Check if there is a power outage in your area.</li> <li>•Turn on the display and see if the problem is with the signal and control system.</li> </ul>
Remote Control is not working.	<ul style="list-style-type: none"> <li>•Check whether something is obstructing the display's remote control receiver.</li> <li>•Check whether the batteries in the remote control are installed correctly.</li> <li>•Check whether the batteries need to be replaced.</li> </ul>
There is no sound when the HDMI in channel is used.	<ul style="list-style-type: none"> <li>•Remove and insert the HDMI cable again.</li> </ul>
The internal PC has no signal.	<ul style="list-style-type: none"> <li>•Check whether the internal PC is properly inserted in the slot.</li> <li>•Check whether the internal PC is in shut down mode.</li> <li>•Press the power button on the internal PC, and manually start up the internal PC.</li> </ul>

### • LED All-IN-ONE Maintenance

The maintenance of LED display system mainly includes the maintenance of LED display system, communication system and power system.

### Precautions for LED display screen

Small pitch LED display screens are high-precision, high-density electronic products, which belongs to precision protection products category. It needs special protections in daily use such as protections from static electricity, dust, moisture and physical impact.

#### 1. Static electricity

LED is an electroluminescence device, which is very sensitive to current. Human body carries static electricity which can break down the internal PN junction. Do not touch the LED display screen without wearing gloves.

#### 2. Dust

The LED display screen is designed according to the indoor IP3X standard, but it contains high-density electronic circuit inside the LED cabinet. So it is very important that the LED display screen is dust proof and clean it regularly.

#### 3. Water vapor and oil fume

LED beads surface can not be treated with water proofing due to its density and sizing, Moisture environment and water vapor can cause short circuit easily which may resulting product failure or even resulting fire that may burnt the LED display screen in the worst case. Therefore, LED display screen needs protection from water vapor and moisture.

#### **4. Physical impact**

The LED display screen is a very delicate device. It needs protection from any kind of physical impact, as it may result in damage to LED beads or circuit board.

##### **Maintenance of LED display screen**

1. The control PC, video processor and other equipment shall be placed in a dry and clean environment with good ventilation. Avoid direct sunlight to all the equipment. The ambient temperature should be kept between 18°C and 25°C.
2. Do not place any container which containing fluid on the screen, to prevent water damage to the product.
3. Turn off the power supply of the corresponding equipment before unplug the cables to prevent damage to the interface components.
4. Avoid the interference of electromagnetic field (such as non magnetic speaker, loudspeaker, etc.).
5. In order to prevent the instantaneous current pulse from affecting the computer, it is advised to turn on the power of the LED display screen first and then the power of the computer. Turn off the power of the computer before the power of the LED display screen when it is shutting down.
6. Always back up important data and files.
7. Do not plug and unplug the communication plugs to prevent damages.
8. External protection measures shall be taken when laying communication cables.
9. Advice on air-conditioner on site: On-site conditioning and other equipment outlet can not be blown against the product. The temperature shall set at  $25 \pm 1$  °C.
10. The LED AIO display shall be well ventilated. The temperature and humidity differences between the inside and outside shall not be greater than 5 degrees;

##### **Maintenance of power system**

1. Daily inspection on power supply system is advised to detect any problems on time.
2. Clean the interior of the distribution cabinet with leather blower or air pressure gun regularly. Fasten any loose screws in the distribution cabinet, it is advised to clean it once a month.
3. Shut off the power supply of the system during thunderstorm season or when it is not being used for a long time.
4. The maintenance of power system shall be carried out only by certified electricians.

##### **Transportation and storage**

###### **1. Transportation**

The LED AIO display is required to be transported after packaging. During transportation, it is strictly prohibited to put the packaging upside down; Avoid rain and snow; Keep out of long time sun exposure; Do not contact with corrosive gas and mechanical damage; Strictly stacking limitation applied (up to two layers). The transportation of PC and power distribution cabinet should be stable, handle with care. Do not put it upside down, keep out of rain and moisture, avoid mechanical damage as well.

###### **2. Storage**

The storage temperature of the display module is  $-20$  °C --  $40$  °C, and the relative humidity is: 10% --70% RH, without condensation. No acid-base and corrosive gas at the storage place, No strong mechanical vibration and do not close to magnetic field. Free of fire and explosion hazards. The storage time shall not exceed 3 months.

# 10

## Specifications

Specification		OP136GE/HAIO136GE	
Physical Parameter	Pixel Pitch(mm)	1.563	
	Pixel Configuration	R/G/B COB	
	Screen Resolution (W×H)	1,920×1,080	
	Display Area (mm)	3,000 × 1,687.5	
	No. of Cabinet Per Screen (W×H)	5×5	
	No. of Modules Per Cabinet (W×H)	4×1	
	Panel Dimensions (W×H×D) (mm)	600×337.5×32.3	
	Aspect Ratio	16:9	
Optical Parameter	Brightness	max 1,000 nits(100-1,000 adjustable ) steady-state peaking 1,400 nits instantaneous peaking 2,100 nits	
	Contrast Ratio	max 25,000:1 / peaking 52,000:1	
	Viewing Angle(H/V)	165°/150°	
	Processing	14 bits	
	Color Temperature	6,500K	
Electrical Parameter	Input Voltage	AC 100-240V~ 50/60Hz	
	Max. Power Consumption(W/Screen)	1,250@600nits 1,720@1,000nits	
	Refresh Rate(Hz)	3,840	
Operation Conditions	Operating Temp/Humidity	0 - 40 °C/ 10% - 90%RH (no frost)	
	Storage Temp/Humidity	-20 - 40 °C/ 10% - 65%RH (no frost)	
Connectivity	Wireless LAN Module specifications	Frequency Range	2.4~2.4835GHz 5.18~5.825GHz
		Output Power (Max.)	2.4G 17dBm 5G 15dBm
	Bluetooth	BT5.2	
	Input	HDMI2.0×3 (HDMI IN1 has eARC functionality)	
	Loop Out	HDMI2.0×1(HDMI IN2 Loop Out)	
	USB	USB3.0×2, USB2.0×1	
	Audio Output	SPDIF×1	
	SERVICE Port	3.5mm	

System	OS	Android 14
	CPU	Cortex-A73 64-bit quad cord
	DDR	8GB
	ROM	128GB
	Language	Chinese/English/Spanish/French/German/Italian/Polish/Arabic/ Russian
Speaker		Built in 60W (10W×6)
Servicing		Front
Optional Accessory		Mobile Cart/Wall bracket/OPS/Dongle

**The supported video formats are as follows:**

Encapsulation	Video decoding				Audio decoding
	Type	Resolution(Max)	Bit rate(Max)	Frame rate(Max)	
.mkv .mp4 .mov	AV1	4,096x2,160	100Mbps	60fps	Dolby Audio,AAC MPEG1(Layer1,2,3)
.avi .mpg .ts	MPEG2	1,920×1,080	60Mbps	60fps	Dolby Audio, MPEG1(Layer1,2,3)
.ts .mkv .avi .mp4 .flv	H.264	4,096×2,160	135Mbps	60fps	Dolby Audio, AAC, MPEG1(Layer1,2,3)
.avi .mkv .mov	MPEG4	1,920×1,080	40Mbps	60fps	Dolby Audio, MPEG1(Layer1,2,3)
.ts .mkv .mp4	H.265	4,096×2,160	100Mbps	60fps	Dolby Audio, AAC, MPEG1(Layer1,2,3)

Dolby Audio: Support Dolby Digital、Dolby Digital Plus、Dolby AC4.

**NOTE**

Formats listed above may not all supported by the device as video making tools are not unified.

Signal formats supported by HDMI port	
RGB/60Hz	640×480 / 800×600 / 1,024×768
YUV/50Hz	576i / 576p / 720p / 1,080i / 1,080p
YUV/60Hz	480i / 480p / 720p / 1,080i / 1,080p
YUV/24Hz 25Hz 30Hz	3,840×2,160 / 4,096×2,160
YUV420/50Hz 60Hz	3,840×2,160 / 4,096×2,160
YUV444/50Hz 60Hz	3,840×2,160 / 4,096×2,160
RGB444/50Hz 60Hz	3,840×2,160 / 4,096×2,160

# 11

## Installation Guide

### 1. Preparations before installation

#### ▣ Requirements for the wall for wall-mounted installation

Types of walls	Types of bolts or screws	Distance between the decorative surface and the wall (A)	Diameter	Bolt embedding depth / Screw screwing depth	Number of bolts or screws	Schematic diagram of the decorated wall	Note
Concrete wall/ Solid brick wall	Metal expansion bolt or nylon expansion bolt	0-20mm	≥M6&ST6	≥50mm	85"≥4; others ≥6		
		20-100mm	≥M6&ST6				
		100-150mm	≥M8&ST8				
		150-200mm	≥M10&ST10	≥6			
		>200mm	Direct installation is not advisable.	/	/		
Hollow brick wall	Hollow wall plug expansion bolt	0-20mm	≥M8	Thickness of the installation surface of hollow bricks ≥30mm	≥6		
		20-100mm	≥M8				
		100-150mm	≥M8				
		>150mm	Direct installation is not advisable.	/	/		
Block brick wall	Mountain-piercing thorn expansion bolt	0-20mm	≥M8	≥50mm	≥6		
		20-100mm	≥M8				
		100-150mm	≥M10				
		>150mm	Direct installation is not advisable.	/	/		
Medium-density and higher fiberboard or solid wood board (18-30mm)	Hollow wall plug expansion bolt	0-20mm	≥M8	Installation plate thickness 18-30mm	≥6		
		20-100mm	≥M8				
		100-150mm	≥M8				
		>150mm	Direct installation is not advisable.	/	/		
Medium-density and higher fiberboard or solid wood board (>30mm)	Wood screw	0-20mm	≥ST5	≥30mm	≥6		
		20-100mm	≥ST5				
		100-150mm	≥ST6				
		150-200mm	≥ST8				
		>200mm	Direct installation is not advisable.	/	/		

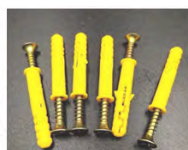

Nylon expansion bolt



Metal expansion bolt



Hollow wall plug expansion bolt



Mountain-piercing thorn expansion bolt



Wood screw



## Power supply requirements

1. The maximum power of the whole machine is 1,720W, and one power cord is used.
2. Please ensure that the power grid has a power supply capacity of at least 220V~/11A.
3. It is recommended to choose a circuit breaker with a rating of 16A and a power source cable of size 14AWG. After installing the circuit breaker, switch the device on and off at least three times. The circuit breaker should not trip and the device should operate normally.





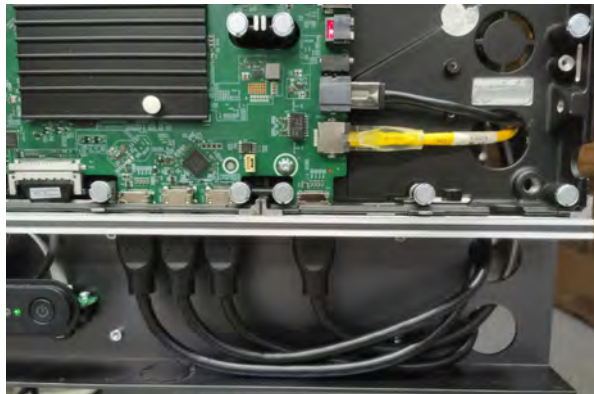
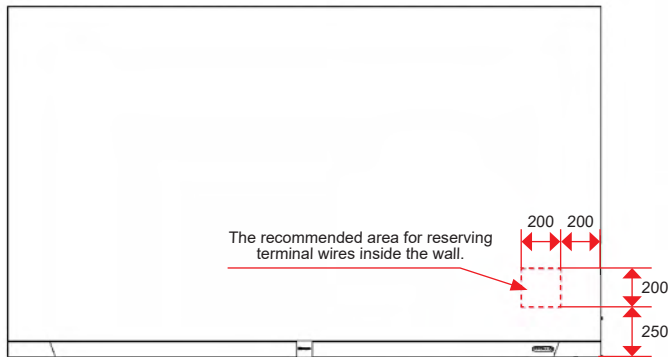



## Heat dissipation guidance and distance requirements for wall-embedding

1. Suggestions for all-in-one machines with bottom terminals: leave a clearance of over 30 mm on the top, left, and right sides. If an OPS computer is used, it is advisable to reserve a space of over 80 mm on the right side for terminal plugging and unplugging, and leave over 80 mm of space at the bottom.
2. Suggestions for all-in-one machines with side-out terminals: leave a clearance of over 30 mm on the top, bottom, and left sides, and over 80 mm on the right side.



Suggested wire management plan for the terminals inside the lower rear front shell.

## Tools for installation

Tool name	Example	Tool name	Example
art knife		Pre-maintenance tools	
Allen key		PH2 Phillips screwdriver	
flexible sleeve		rubber mallet	
laser level		pneumatic drill	

## Ceiling, reserved space above

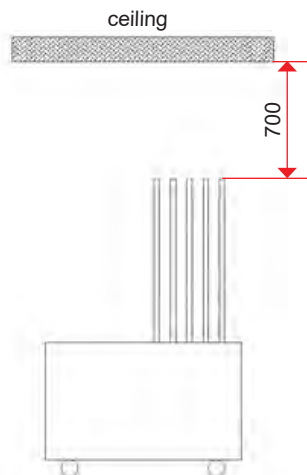

It is recommended that the reserved clearance between the bottom of the whole machine and the ceiling be greater than 700 mm.

## Precautions related to building construction

- When installing at the construction site, please make sure to carry out the installation after the construction and cleaning are completed.
- If the product must be installed in a decoration work environment, please take the following measures:
  - A shielding film should be installed to protect the product by sealing the entire product, preventing it from coming into contact with dust and various liquids.
  - Play videos or a 100% gray whiteboard for more than 2 hours every day.
  - After the construction is completed, remove dust, various liquids and vapors, dismantle the protective cover, and activate the dehumidification mode.

## 2. Installation

### Assembly materials

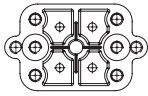

Connecting block



M6 stepped screw  
(A)



Connecting screw  
M6×16 (B)



M8 wall-mount screw  
(C)

### Wall-mounted assembly

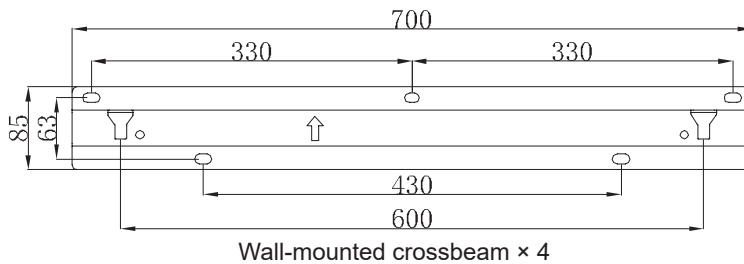

Screw ST8×55 (D)



Expansion pipe (E)



M6×25 (F)

### Front shell assembly

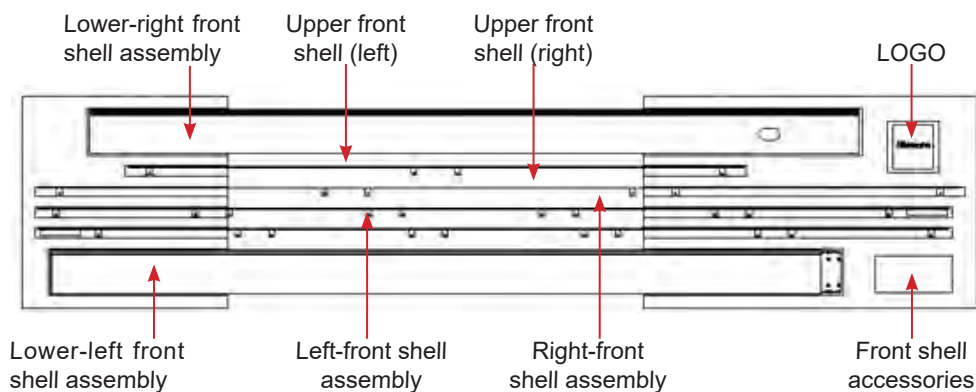

### Screws for front shell accessories

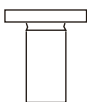

M4×8 (G)

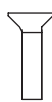

M3×8 (H)



M6×12 (J)



M3×6 (K)

## ❏ Pre-installation of the front shell assembly

1. Take out the left, right, and lower front shell components from the front shell packaging box. Unscrew the 4 M3×8 screws at each end respectively (a total of 8 screws on the left and right sides. Pay attention to keeping the removed screws). Then remove the mesh cover plates of the left, right, and lower front shell components respectively and put them aside. Pay attention to protecting the upper front shell to avoid damage and scratches.

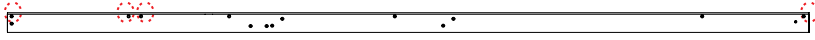

Unscrew the four screws at the positions shown in the diagram on the left, right, and lower front shell components respectively.

### 2. OPS (Optional) and front shell assembly

- 1) Take out the OPS box from the accessory box, and fix the 4 M3 step screws in the box to the position shown in the lower right front shell assembly.

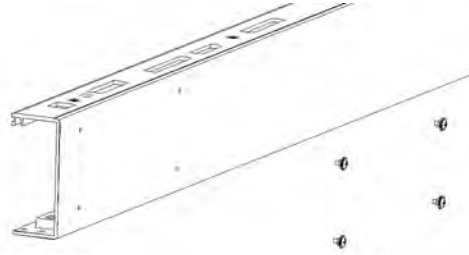

- 2) Take out the OPS, insert the OPS into the bracket, tighten the 2 hand screws after inserting them in place, and put them aside for later use, pay attention to protection to avoid falling and scratching.

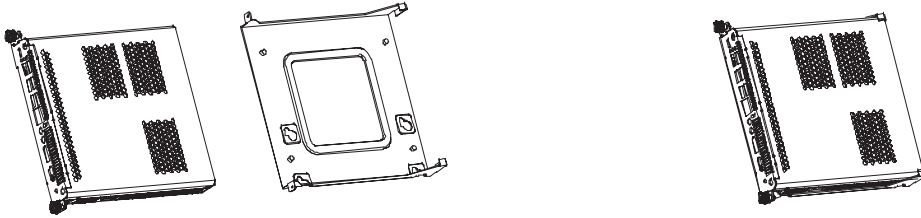

- 3) After the assembly of the whole machine is completed, the assembled OPS assembly is hooked to the corresponding position of the lower right front shell.

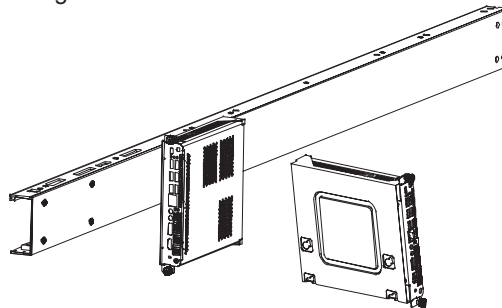

3. Assemble the left, right, lower, rear and front shells. Join the left, right, lower, rear and front shells together according to the positions shown in the diagram. Then use 6 M4×8 screws (Ⓢ) to fix the left and right rear covers of the lower front shell together. Place the assembled lower, rear and front shell assembly aside for later use. Pay attention to protection to avoid damage or scratches.

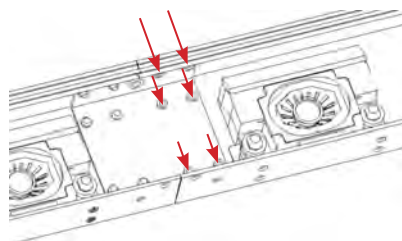

## ❏ Unboxing item list

LED cabinet × 5 columns

Wall-mounted assembly × 1 carton

Spare parts × 1 carton

Accessory × 1 carton

Front shell assembly × 1 carton

Light board assembly × 5 cartons (20 pieces/carton)

Assembly materials × 1 carton

## ❏ Wall-mounted assembly installation(Reference screws for different wall types)

Open the wall-mounted component packaging box, take out the wall-mounted bracket and the included screws. According to the position and dimensions of the wall-mounted component and the whole machine in the following figure, fix the four crossbeams on the wall respectively (use 5 screws ST8×55 (D) and 5 nylon expansion tubes (E) for each crossbeam). Note that when drilling holes in the wall, calculate the position and dimensions of the holes on the wall accurately based on the position and dimension diagram of the whole machine and the wall-mounted component.

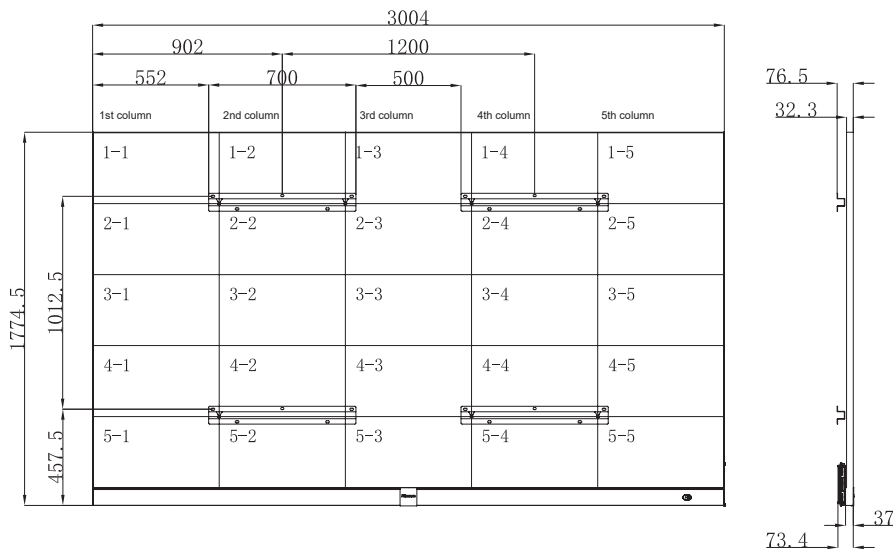

## ❏ Cabinet assembly installation (5×5)

1. Take out the third column cabinet. Refer to the figure below: use sixteen M6×16 connecting screws (B) to fasten eight cabinet connectors to the cabinet, then use four M8 wall-mounting screws (C) to secure the four cabinet connectors at the positions shown in the figure.

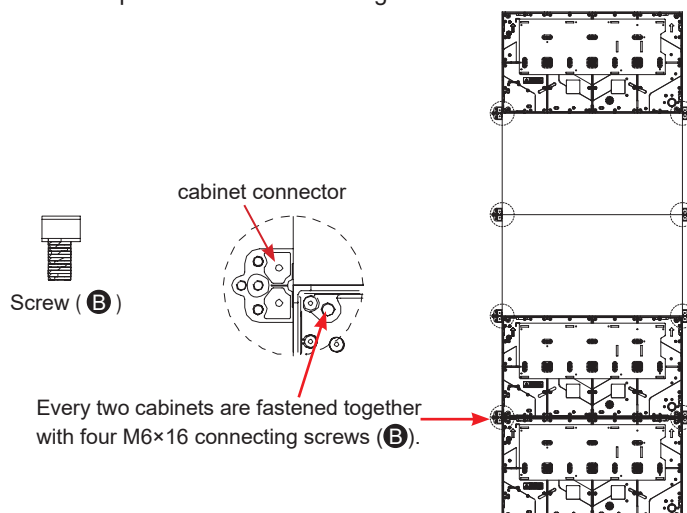

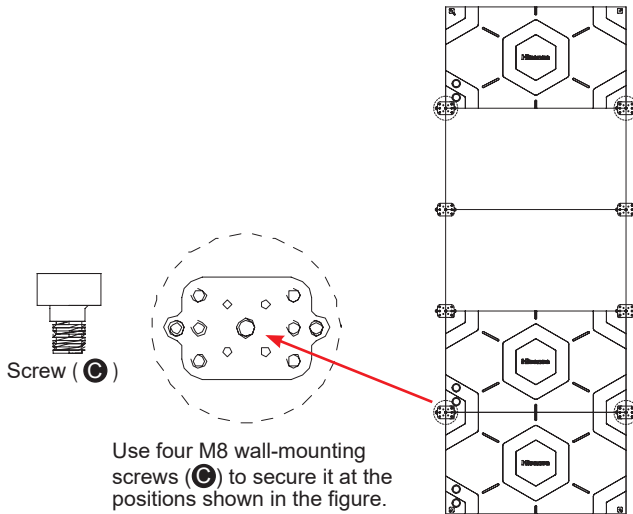

2. Hang the third-column cabinet— assembled with the cabinet connectors and wall-mounting screws— onto the wall-mount crossbeam that has already been secured. The hanging positions are as shown in the figure, then secure two M6×25 countersunk screws (E) at the positions indicated.

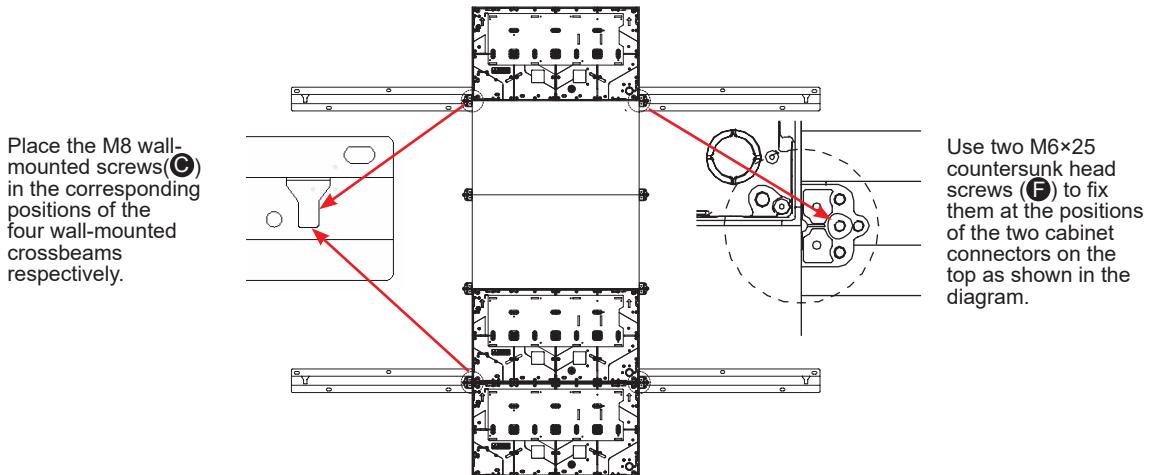

3. Hang the assembled lower rear front cover assembly onto the third-column cabinet, and use two M6×12 screws (J) from the front-cover accessory kit to fasten the bottom cabinet in the third column to the lower rear front cover assembly.

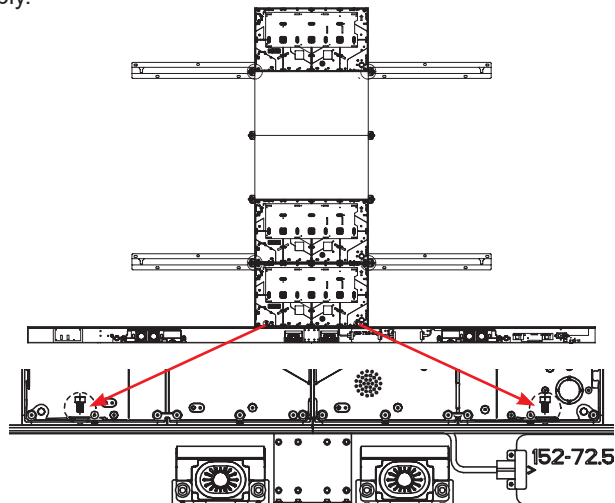

4. Take out the second-column cabinet. Use eight M6×16 connecting screws (B) to fasten four cabinet connectors to the left side of the cabinet, then use two M8 wall-mounting screws (C) to secure the two cabinet connectors at the positions shown in the figure.

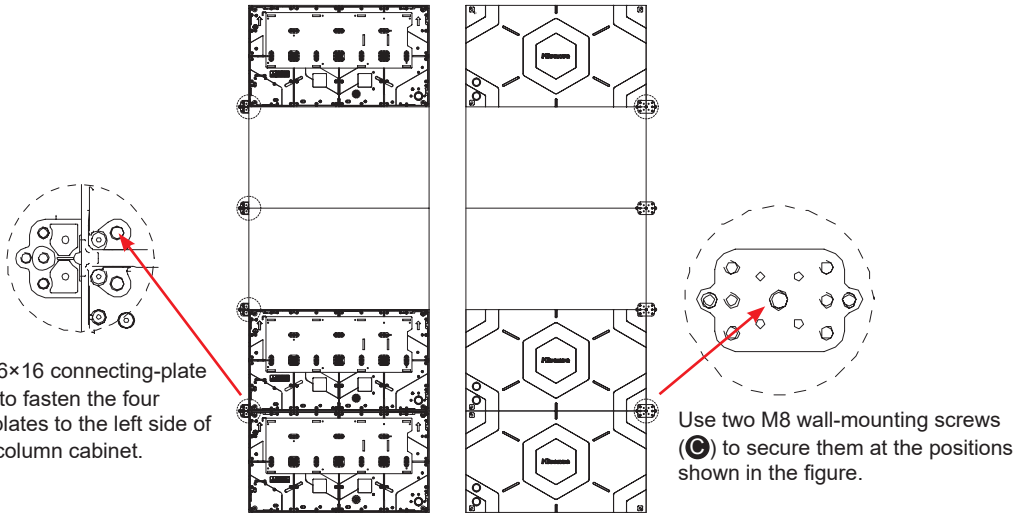

5. Hang the second-column cabinet—already fitted with the cabinet connectors and wall-mounting screws—onto the left side of the third-column cabinet. First, use ten M6 step screws (A) to secure the third-column cabinet to the second-column cabinet (Note: during this step, ensure the joint between columns 2 and 3 is free of bright lines and step mismatch). Then use eight M6×16 connecting screws (B) to fasten the connectors on the right side of the second-column cabinet to those on the left side of the third-column cabinet. Finally, use two M6×12 screws (J) from the front-cover accessories to secure the cabinet to the front-cover assembly.

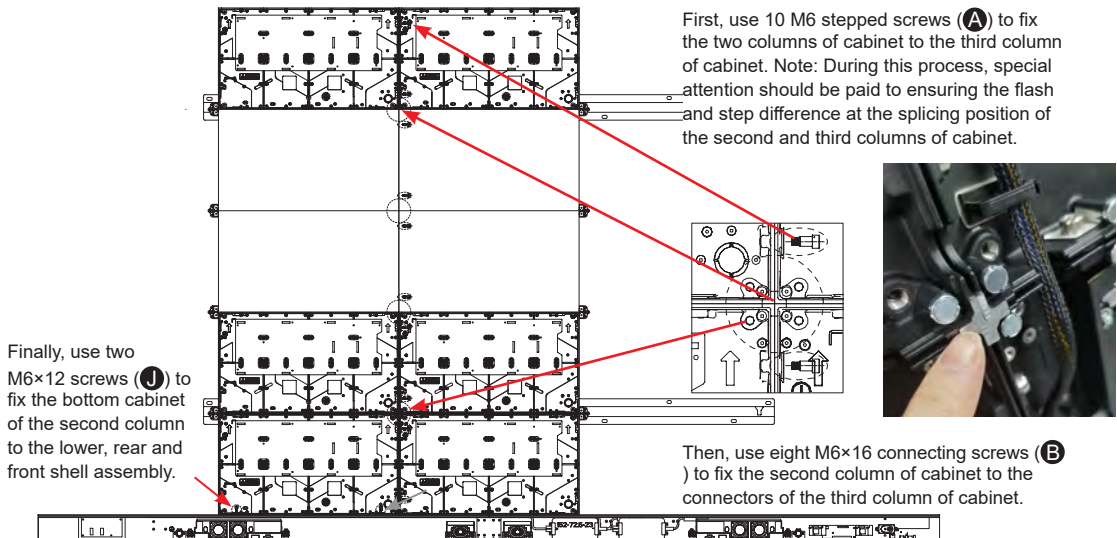

6. Refer to Steps 4 and 5 to complete the assembly of the fourth - column cabinet with the third - column cabinet and the lower, rear and front shell. Also, pay attention to the flash and step difference at the splicing position.

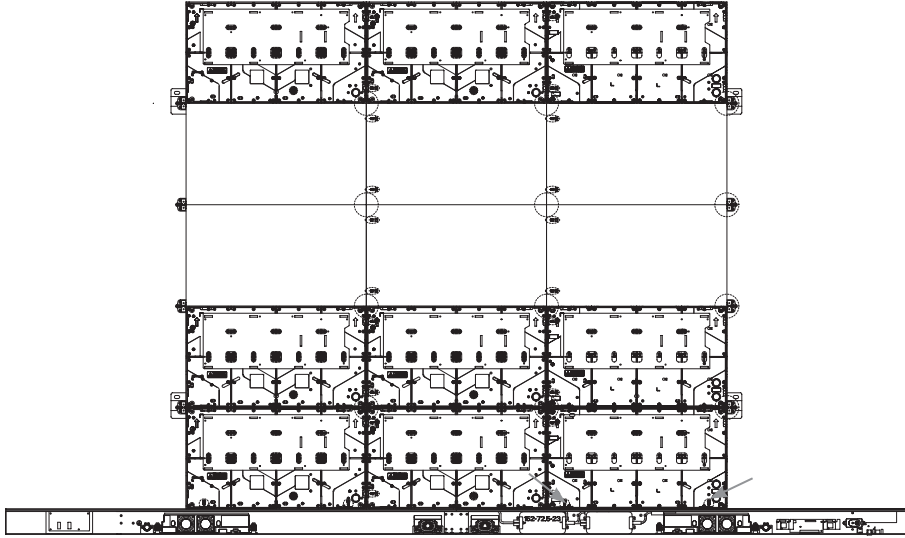

Schematic diagram of the assembled second, third, and fourth columns of cabinets.

7. Take out the first-column cabinet and lift it to the left side of the second-column cabinet. First, use ten M6 stepped screws (A) to fix the second-column cabinet to the first-column cabinet (Note: In this process, special attention should be paid to ensuring that there is no flash or step difference at the splicing position of the first and second columns of cabinet). Then, use eight M6×16 connecting screws (B) to fix the first-column cabinet to the connecting piece on the left side of the second-column cabinet. Finally, use two M6×12 (J) screws from the front-shell accessories to fix the lower cabinet to the front-shell assembly.



Before fixing the first column of cabinets and the second column of cabinets, first pass the power cord through the hole shown in the diagram on the cabinet in the 5th row of the 1st column, and then use screws to fix the power cord to the screw posts shown in the diagram.

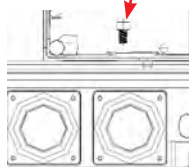

Finally, use two M6×12 screws (J) to fix the bottom cabinet of the first column to the lower, rear and front shell assembly.

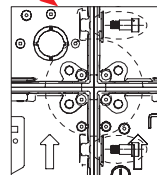

First, use ten M6 stepped screws (A) to fix the second - column cabinet to the first - column cabinet. Note: In this process, special attention should be paid to ensuring that there is no flash or step difference at the splicing position of the first and second columns of cabinet. Then, use eight M6×16 connecting screws (B) to fix the first - column cabinet to the connecting piece of the second - column cabinet.



## ❏ Connection

Connection of FFC signal cables



FFC signal cables connection for HAIO136GE(five by five)

The following instructions are for making connections in the order from left to right and from bottom to top.

Connection of 5-1 and 5-2 as shown in the figure below.

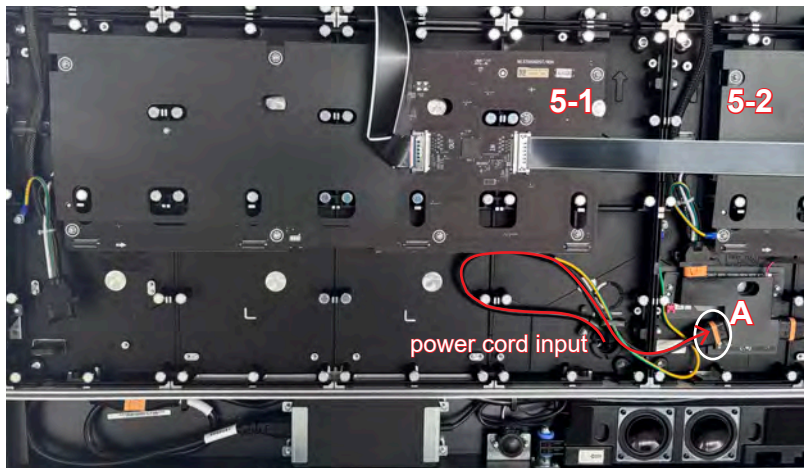

Connection of 5-2 and 5-3 as shown in the figure below.

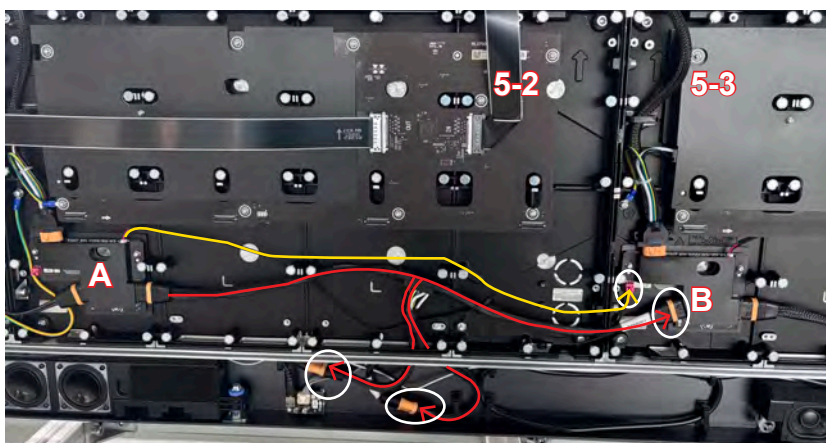

Connection of 5-3 and 5-4 as shown in the figure below.

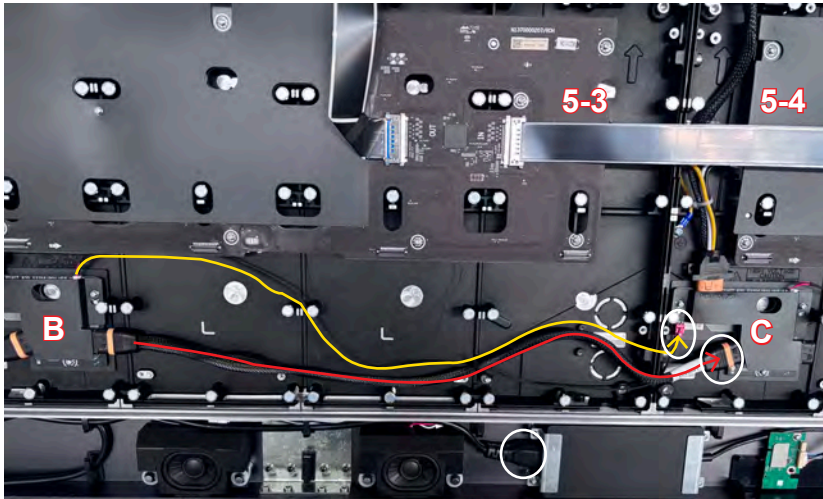

Connection of 5-4 and 5-5 as shown in the figure below.

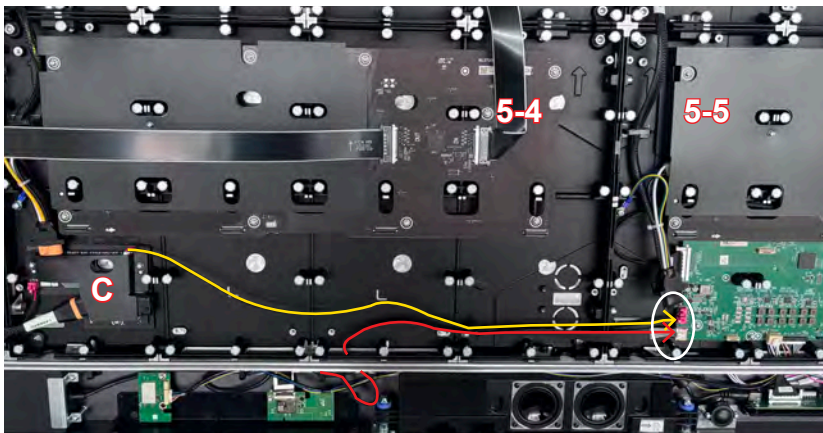

5-5 mainboard connections are shown in the figure below.

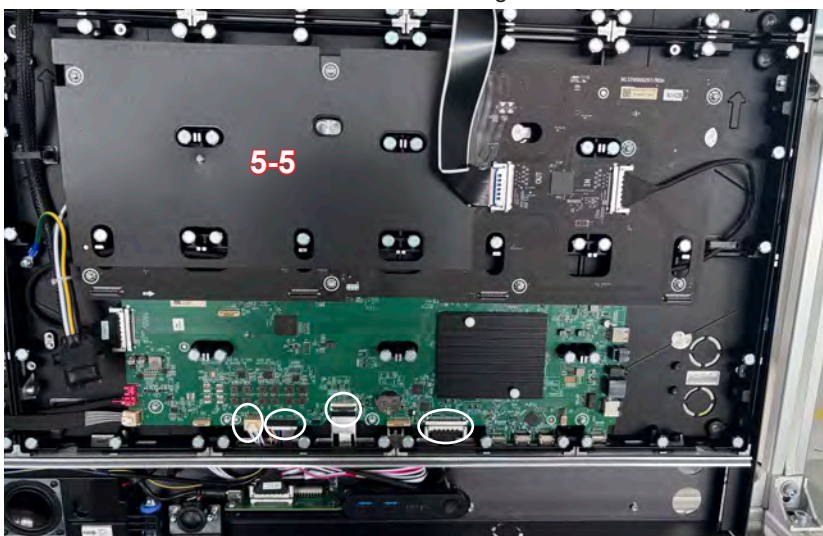

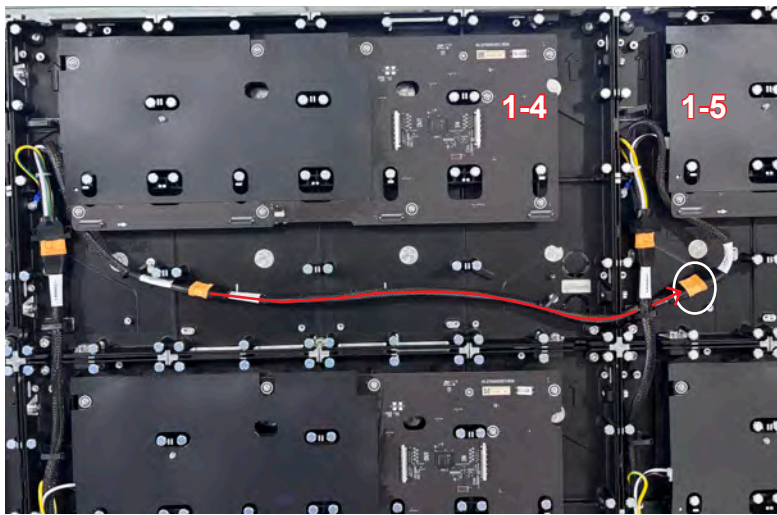
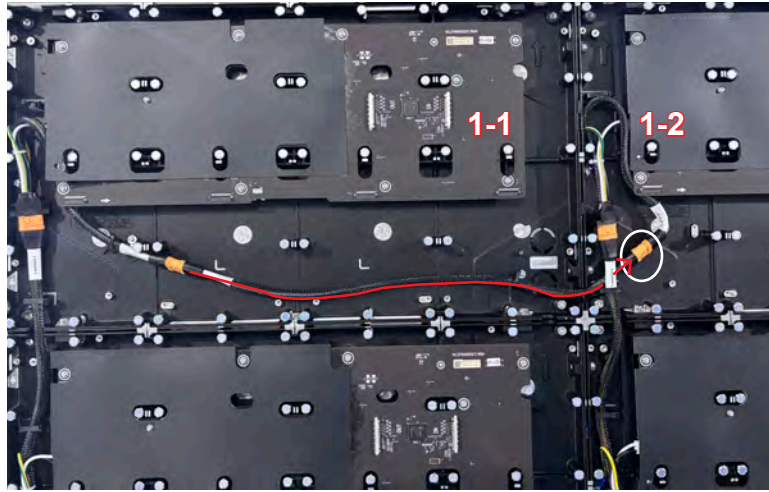

Connection of the speakers are shown in the figure below.

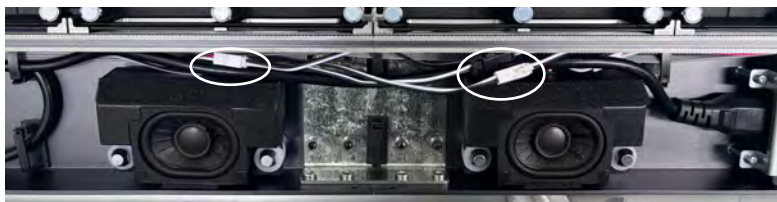

After all the power supply lines and signal lines are connected and it is checked that there are no problems with the connections, power on the system. After confirming that the power supply indicator lights on all HUB boards turn white, proceed with the installation of the light boards.

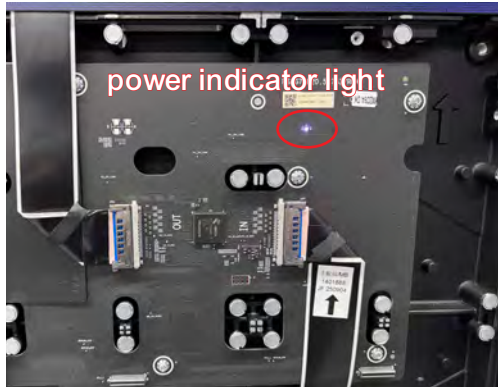

The final power cable connection diagram is as follows.

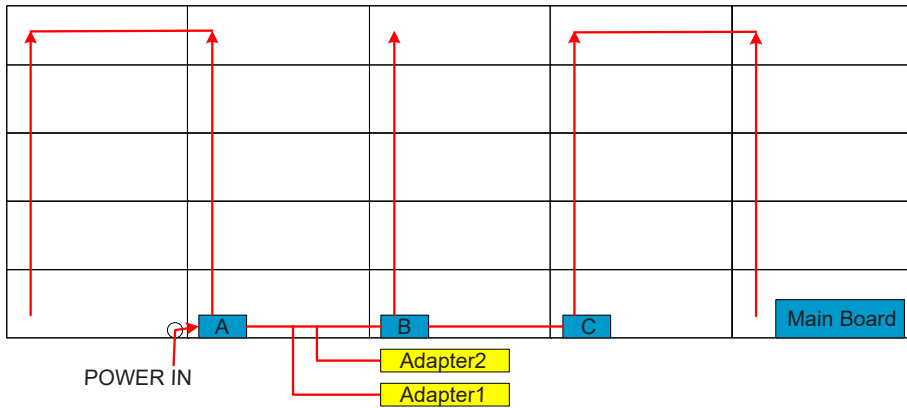

OPS signal cable connection shown in the figure below.

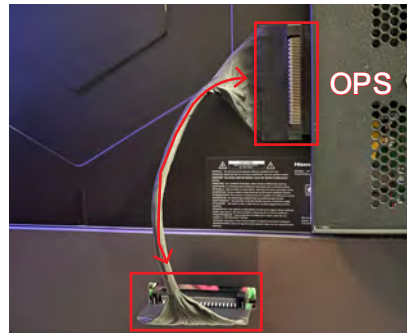
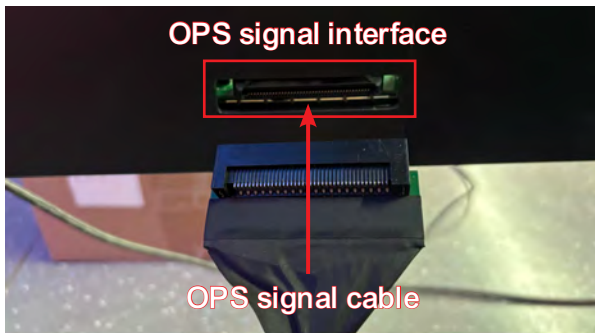

## Light board installation

Start installing the light boards from the 5th row of the 1st column. Install 5-1-01, 5-1-02, 5-1-03 in sequence until 5-5-03 and 5-5-04. After the installation of the light boards in the 1st row is completed, install those in the 4th row, and then install the light boards in the 3rd row, the 2nd row, and the 1st row in order. Pay attention to the flatness and step difference during the installation of the light boards.

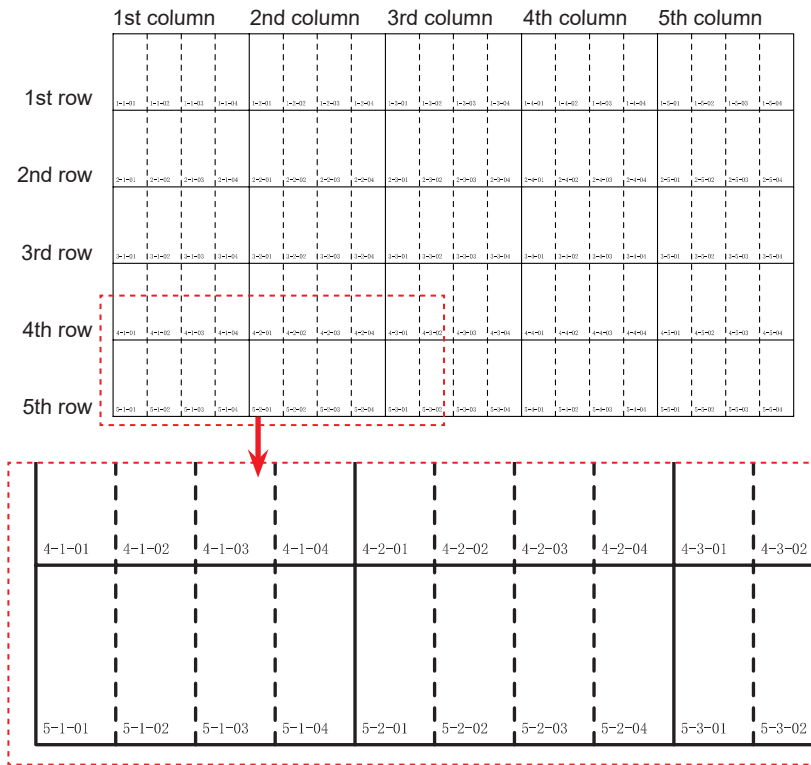

After the installation of the light boards is completed, assemble the front lower shell panel onto the rear lower shell assembly. Use M3×8 screws (H) to fix the front and rear parts of the lower shell. After that, attach the logo assembly to the lower front shell assembly. (Note: Place the two positioning posts of the logo into the corresponding positioning holes of the lower front shell.)

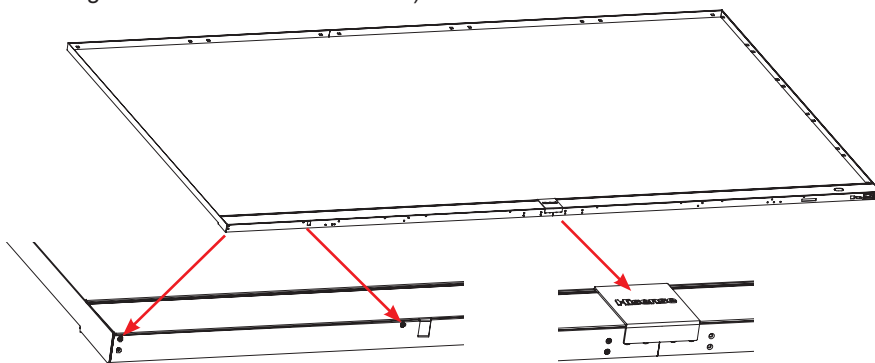

# 12 Maintenance

## 1. Dehumidification

LED displays are products sensitive to temperature and humidity. During use, the temperature and humidity of the environment need to be controlled:

- ① When the environmental humidity is within the range of 35% - 55%RH, it is recommended to turn on the display screen once a week and use it normally for more than 4 hours each time to remove the moisture from the display screen.
- ② When the environmental humidity is above 55%RH, dehumidification treatment of the environment is required. It is recommended to use the display screen normally for more than 8 hours per week to prevent the display screen from being affected by moisture, which may cause malfunctions.
- ③ When the display screen has not been used for a long time, pre-heating and dehumidifying the display screen are necessary before use to avoid malfunctions of the light tubes caused by moisture. The specific method is as follows: light up the screen at 0% brightness for 2 hours, then at 10% brightness for 2 hours, 20% brightness for 2 hours, 40% brightness for 2 hours, 60% brightness for 2 hours, and gradually increase the brightness for aging. This product can perform the automatic dehumidification function to assist in achieving dehumidification.

## 2. Screen cleaning

### Cleaning tools

Tools	Recommended choices	No use
Wiping cloth	Lint-free and soft microfiber cloths (such as lint-free cleaning cloths and eyeglass cleaning cloths); they must be brand - new or thoroughly cleaned to avoid adhering hard particles.	Rough towels, paper tissues, chemical fiber fabrics.
Cleaning fluid	Special screen cleaner or distilled water (tap water should not be used as water scale will remain).	Solutions containing alcohol, ammonia, strong acids or strong alkalis.
Auxiliary tools	Soft brush, compressed air canister (cold air).	Hard brush, heat gun, blade, high-pressure water gun, etc.

### Necessary preparations before cleaning

Power off and cool down: Turn off the power, unplug the plug, and wait for the screen to cool down completely (at least 30 minutes). This helps avoid the risks of static electricity or short-circuits and prevents the cleaning agent from evaporating and leaving marks.

### Environment selection

Operate in a dust-free and low-humidity environment to avoid secondary pollution during the cleaning process.

### Screen cleaning

#### 1. Cleaning of surface dust

Use a soft brush or a compressed air canister (keep a distance of  $\geq 20$  cm from the screen) to gently remove the dust in the gaps and on the surface. Direct wiping is prohibited! Dust particles may scratch the screen.

#### 2. Wet wiping for stain removal

Step 1: Fold a slightly damp cleaning cloth and gently wipe the screen in one direction (e.g., horizontally).

Step 2: For stubborn stains, dip the cloth in a small amount of cleaning agent and soften the dirt by making small circles. Then wipe it clean in one direction.

Step 3: Immediately dry the water marks with a dry microfiber cloth to avoid leaving stains after drying.

Notes:

- The cleaning agent or distilled water must be sprayed on the microfiber cloth (never spray directly on the screen).
- Gently wipe in one direction (e.g., horizontally), avoiding circular motions or pressing hard.
- For stubborn stains, you can increase the amount of cleaning agent, but make sure the cloth is slightly damp rather than dripping wet.

#### 3. Drying and inspection

Let it air - dry naturally for 5 minutes, or pat dry the remaining water marks with another dry microfiber cloth. Check for water stains or scratches under strong light.

### 3. HUB Board Replacement Precautions

#### Safety Precautions

- Power off the equipment and unplug the power cord before replacement.
- Wear anti-static wrist strap to prevent ESD damage.
- Ensure adequate lighting and proper workspace.

#### Installation Guidelines

Before replacing the HUB board, please power off the machine and unplug the power cord.

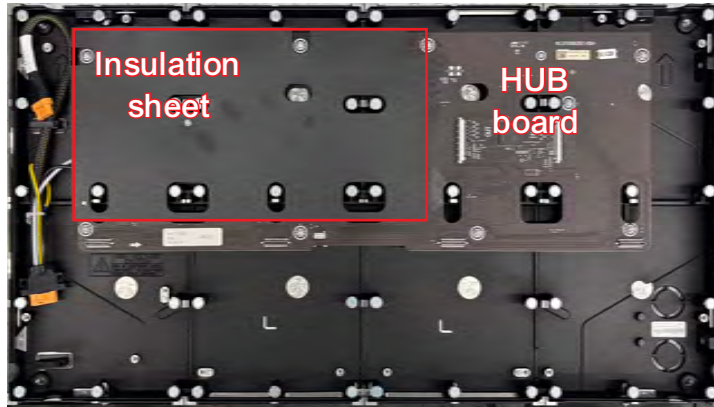

Step1: Unplug the power connector, unscrew ten screws and remove the insulation sheet.

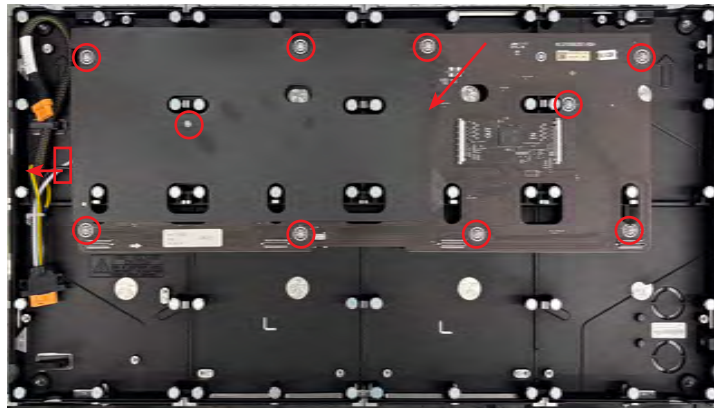

Step2: Remove the HUB board.

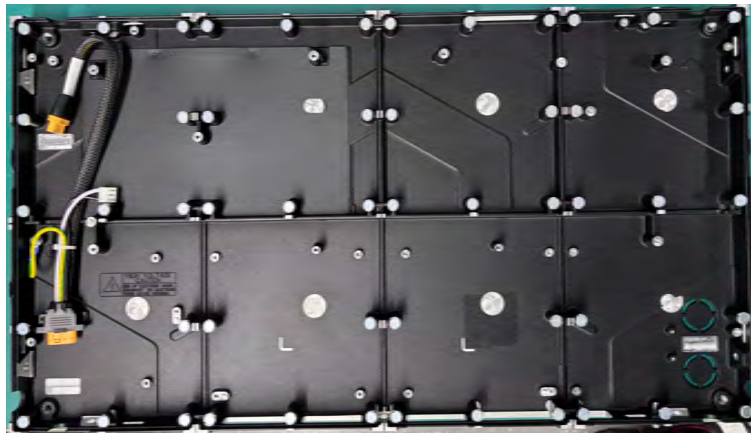

Step3: Replace the HUB board, insert the power cable connector, apply the insulation sheet, and secure with ten screws.

- Handle the HUB board carefully, avoid bending or touching circuit components.
- Align the board with positioning pins before installation.
- Apply insulation sheet where required.
- Secure with ten screws evenly (do not overtighten).
- Ensure insert the power cable connector.
- Verify power cable connection is secure.

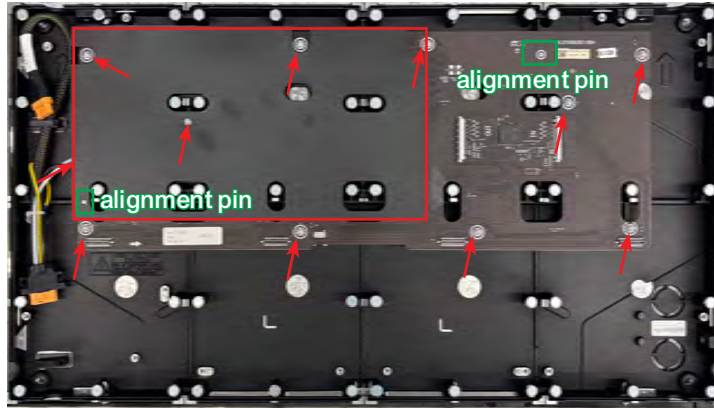

This warning indicates that after replacing the HUB board and powering on again, the corresponding cabinet will have no image display for a period because the HUB board needs to reload the light board data. It is crucial not to power off during this power-on process. This is to ensure the successful loading of data and avoid potential issues caused by interrupting the process.

#### 4. LED Cabinet Brightness Inconsistency - Operating Instructions

If the LED cabinet brightness appears different from others during the first power-on or after HUB replacement, adjust according to the following steps.

Step1: Take out the remote control and press the SET button.



Step2: Select in the following menu order. Image→Comfort Vision→LED Brightness Level, then adjust the LED Brightness Level value-increase or decrease it, then return to the original.

# Hisense

**Company Name:**

Hisense Commercial Display Co.,Ltd.

**Address:**

No. 218, Qianwangang Road, Huangdao District, Qingdao,  
Shandong, P.R. China

**Made in China**